

2019

Factors Affecting Systems Engineering Rigor in Launch Vehicle Organizations

Denton Gibson
University of Central Florida

 Part of the [Industrial Engineering Commons](#), and the [Systems Engineering Commons](#)
Find similar works at: <https://stars.library.ucf.edu/etd>
University of Central Florida Libraries <http://library.ucf.edu>

STARS Citation

Gibson, Denton, "Factors Affecting Systems Engineering Rigor in Launch Vehicle Organizations" (2019).
Electronic Theses and Dissertations. 6743.
<https://stars.library.ucf.edu/etd/6743>

This Doctoral
Dissertation (Open
Access) is brought
to you for free and
open access by
STARS. It has been
accepted for
inclusion in
Electronic Theses
and Dissertations by
an authorized
administrator of
STARS. For more
information, please
contact
lee.dotson@ucf.edu.



FACTORS AFFECTING SYSTEMS ENGINEERING RIGOR IN LAUNCH VEHICLE
ORGANIZATIONS

by

DENTON GIBSON

Bachelor of Science in Electrical Engineering, University of Florida, 2003
Master of Science in Industrial Engineering, University of Miami, 2006

A dissertation submitted in partial fulfillment of the requirements
for the degree of Doctor of Philosophy
in the Department of Industrial Engineering and Management Systems
in the College of Engineering and Computer Science
at the University of Central Florida
Orlando, Florida

Fall Term
2019

Major Professor: Waldemar Karwowski

ABSTRACT

Systems engineering is a methodical multi-disciplinary approach to design, build, and operate complex systems. Launch vehicles are considered by many extremely complex systems that have greatly impacted where the systems engineering industry is today. Launch vehicles are used to transport payloads from the ground to a location in space. Satellites launched by launch vehicles can range from commercial communications to national security payloads. Satellite costs can range from a few million dollars to billions of dollars. Prior research suggests that lack of systems engineering rigor as one of the leading contributors to launch vehicle failures. A launch vehicle failure could have economic, societal, scientific, and national security impacts. This is why it is critical to understand the factors that affect systems engineering rigor in U.S. launch vehicle organizations.

The current research examined organizational factors that influence systems engineering rigor in launch vehicle organizations. This study examined the effects of the factors of systems engineering culture and systems engineering support on systems engineering rigor. Particularly, the effects of top management support, organizational commitment, systems engineering support, and value of systems engineering were examined. This research study also analyzed the mediating role of systems engineering support between top management support and systems engineering rigor, as well as between organizational commitment and systems engineering rigor. A quantitative approach was used for this. Data for the study was collected via survey instrument. A total of 203 people in various systems engineering roles in launch vehicle organizations throughout the United States voluntarily participated. Each latent construct of the study was validated using confirmatory factor analysis (CFA). Structural equation modeling (SEM) was used to examine the relationships between the variables of the study. The IBM SPSS Amos 25 software was used to analyze the CFA and SEM.

This work is dedicated to my father, Oliver Pedro Gibson, who I lost during my doctoral research. He taught me the value of a good education, was always supportive of me, and even after he is gone is continuing to inspire me to succeed.

ACKNOWLEDGEMENTS

First and foremost I would like to thank God for everything He has given me and blessing me with the opportunity pursue my PhD. I would like to give a special thanks and appreciation to my PhD advisor Dr. Waldemar Karwowski for his guidance and assistance throughout the entire process. I would also like to thank the members of my dissertation committee: Dr. Tim Kotnour, Dr. Luis Rabelo, and Dr. David Kern for their time and guidance throughout this process. I would also like to thank Liz Stalvey, the IEMS coordinator, whose help was instrumental in getting me through this entire process.

Next I would like to give a special thanks and my gratitude to leadership of the NASA Launch Services Program and Kennedy Space Center for granting me the opportunity, support, and flexibility for me to pursue my PhD.

I would also like to acknowledge systems engineering researchers and doctoral candidates that came before me, who provided a good foundation for my research to build upon.

I would also like express my love and appreciation form my family who continued to give me their love and support throughout this entire process.

TABLE OF CONTENTS

LIST OF FIGURES	x
LIST OF TABLES.....	xiii
LIST OF ACRONYMS	xvi
CHAPTER I: INTRODUCTION.....	1
1.1 Background.....	1
1.2 Problem Statement.....	2
1.3 Hypothesis	5
1.4 Research Objectives	6
1.5 Research Limitations	7
1.6 Definition of Terms	8
1.7 Assumptions	9
1.8 Significance of Study.....	9
CHAPTER II: LITERATURE REVIEW	11
2.1 Methodology of Review	11
2.2 Foundation of Systems Engineering.....	12
2.3 Value of Systems Engineering	14
2.4 Systems Engineering Concepts	18
2.4.1 Systems Thinking.....	18

2.4.2 Holistic Lifecycle View	19
2.5 Traditional Systems Engineering.....	23
2.5.1 Waterfall.....	24
2.5.2 Vee	25
2.6 Recent Systems Engineering Approaches	26
2.6.1 Lean Systems Engineering.....	27
2.6.2 Agile Systems Engineering.....	30
2.6.3 Model-Based Systems Engineering	34
2.7 Systems Engineering Best Practices and Standard.....	35
2.8 Systems Engineering Metrics	43
2.9 Implementing Systems Engineering.....	48
2.9.1 Planning, Controlling, and Assessment.....	48
2.10 Enabling Systems Engineering.....	50
2.10.1 Systems Engineering Culture.....	50
2.10.2 Systems Engineering Competencies	53
2.11 Assessing Systems Engineering	53
2.11.1 Best Practices for Project Assessment and Control.....	55
2.12 Critical Success Factors.....	56
2.12.1 Project Management and System Engineering.....	56

2.12.2 Critical Success Factors of Project Management	57
2.13 Systems Engineering and Launch Vehicle Failures	60
2.14 Gaps in Literature and Obstacles	61
2.15 Literature Review Conclusion	64
CHAPTER III: METHODS AND PROCEDURES	67
3.1 Introduction	67
3.2 High-Level Research Method.....	67
3.3 Research Design	69
3.4 Research Model	71
3.5 Survey Approach	72
3.5.1 Research Variables.....	73
3.6 Pilot Survey Study	81
3.7 Validity of Research Methodology.....	82
3.7.1 Construct Validity	82
3.7.2 Internal Validity	83
3.7.3 External Validity	83
3.7.4 Reliability.....	84
3.7.5 Potential Sources of Bias.....	85
3.8 Data Collection and Analysis	87

3.8.1 Survey Process	87
3.8.2 Survey Data Analysis	93
CHAPTER IV: RESEARCH FINDINGS.....	101
4.1 Descriptive Statistics Analysis of Control Variables.....	101
4.2 Testing Assumptions	103
4.2.1 Normality, Linearity, and Homoscedasticity Check	104
4.2.2 Multicollinearity Assessment.....	105
4.3 Confirmatory Factor Analysis	107
4.3.1 Exogenous Variables.....	109
4.3.2 Endogenous Variables.....	126
4.3.3 Hypothesized Systems Engineering Culture, Support, and Rigor Model	143
4.4 Structural Equation Modeling	156
4.4.1 Validating the Structural Model.....	158
4.4.2 Hypothesis Testing.....	165
CHAPTER V: DISCUSSION, LIMITATIONS, IMPLICATIONS, FUTURE RESEARCH, AND CONCLUSION.....	172
5.1 Discussion.....	172
5.2 Limitations.....	177
5.3 Implications	177

5.4 Future Research.....	179
5.5 Conclusion.....	179
APPENDIX A: SURVEY INSTRUMENT.....	182
APPENDIX B: IRB APPROVAL.....	192
APPENDIX C: ASSUMPTIONS CHECK PLOTS.....	194
REFERENCES.....	216

LIST OF FIGURES

Figure 2.3-1: Program Budget Overrun vs Money Spent on Systems Engineering	15
Figure 2.4-1: Logic Model for Generic Systems Engineering Life-Cycle.....	20
Figure 2.5-1: Waterfall Model	24
Figure 2.5-2: Vee Model.....	25
Figure 2.6-1: Stelzmann’s Agile Systems Engineering Action Model	33
Figure 2.10-1: Safety Culture Pyramid	52
Figure 3.2-1: High-Level Research Methodology	68
Figure 3.3-1: Research Design.....	70
Figure 3.4-1: Research Model.....	72
Figure 3.8-1: Survey Development Process.....	91
Figure 3.8-2: Survey Data Analysis Process.....	94
Figure 4.1-1: Job Position Distribution.....	102
Figure 4.3-1: Initial Top Management Support Model.....	110
Figure 4.3-2: Revised Top Management Support Model.....	111
Figure 4.3-3: Organizational Commitment Measurement Model.....	113
Figure 4.3-4: Initial Value of SE Measurement Model.....	115
Figure 4.3-5: 1 st Revised Value of SE Measurement Model	116
Figure 4.3-6: 2 nd Revise Value of SE Measurement Model.....	118

Figure 4.3-7: Initial Communication Measurement Model	120
Figure 4.3-8: Revised Communication Measurement Model	121
Figure 4.3-9: Initial Systems Engineering Culture Measurement Model	122
Figure 4.3-10: Revised Systems Engineering Culture Model.....	125
Figure 4.3-11: Control and Assessment Measurement Model.....	127
Figure 4.3-12: Initial Personnel Measurement Model	128
Figure 4.3-13: Revised Personnel Measurement Model	130
Figure 4.3-14: Initial Planning Measurement Model.....	131
Figure 4.3-15: Revised Planning Measurement Model	132
Figure 4.3-16: Tools and Infrastructure Measurement Model	134
Figure 4.3-17: Systems Engineering Support Measurement Model	136
Figure 4.3-18: Revised Systems Engineering Support Measurement Model	139
Figure 4.3-19: Systems Engineering Rigor Measurement Model.....	140
Figure 4.3-20: Revised Systems Engineering Rigor Measurement Model.....	142
Figure 4.3-21: Initial Hypothesized Systems Engineering Culture-Support-Rigor Model.....	145
Figure 4.3-22: Revised 1 st Order Hypothesized Model	146
Figure 4.3-23: 2 nd Revised Hypothesized Model.....	150
Figure 4.3-24: 3 rd Revised Hypothesized Model	151
Figure 4.4-1: Hypothesize Structural Model (Hyper Model).....	158

Figure 4.4-2: Hypothesized Structural Model (Composite Model)	159
Figure 4.4-3: 1 st Revised Hypothesized Structural Model (Composite Model).....	160
Figure 4.4-4: 2 nd Revised Hypothesized Structural Model (Composite Model).....	161
Figure 4.4-5: Final Structural Hyper Model	170
Figure 4.4-6: Final Structural Composite Model	171

LIST OF TABLES

Table 1.3-1: Research Hypotheses.....	5
Table 1.6-1: Definition of Terms	8
Table 2.7-1: Systems Engineering Standards Comparison.....	39
Table 2.12-1: Fortune and White's Compiled List of Project Critical Success Factors	59
Table 2.13-1: A Systems Engineering Look at 50 Space Systems Failures Summary.....	61
Table 3.8-1: Data Collection Approach	87
Table 3.8-2: Survey Likert Scale	92
Table 3.8-3: Factor Loading Interpretation.....	97
Table 4.1-1: Job Position Frequencies	102
Table 4.1-2: Demographics Descriptive Statistics	103
Table 4.2-1: Variable Abbreviations.....	104
Table 4.2-2: Summary of Correlation Matrices Assessment	107
Table 4.3-1: Top Management Support Measurement Model Parameter Estimates	112
Table 4.3-2: Organizational Commitment Measurement Model Parameter Estimates	114
Table 4.3-3: Value of SE Measurement Model Parameter Estimates.....	117
Table 4.3-4: Communication Model Parameter Estimates	120
Table 4.3-5: System Engineering Culture Parameter Estimates	124
Table 4.3-6: Systems Engineering Culture Model Fit	125

Table 4.3-7: Control and Assessment Parameter Estimates.....	127
Table 4.3-8: Personnel Model Parameter Estimates.....	129
Table 4.3-9: Planning Model Parameter Estimates.....	132
Table 4.3-10: Tools and Infrastructure Model Parameter Estimates.....	134
Table 4.3-11: Systems Engineering Support Parameter Estimates.....	137
Table 4.3-12: SES Model Fit Indices.....	138
Table 4.3-13: SES Modification Indices.....	138
Table 4.3-14: Systems Engineering Rigor Parameter Estimates.....	141
Table 4.3-15: Systems Engineering Rigor Model Fit Indices.....	141
Table 4.3-16: Initial SER Model Modification Index Values Above 10.....	142
Table 4.3-17: Modification Indices for Initial SE Culture-Support-Rigor Model.....	148
Table 4.3-18: Correlations of Latent Variables of Hypothesized Model.....	149
Table 4.3-19: Hypothesized Measurement Model Fit Indices.....	152
Table 4.3-20: Descriptive Statistics, Cronbach's α , and Correlations of Latent Constructs.....	152
Table 4.3-21: Convergent Validity.....	154
Table 4.3-22: Discriminant Validity.....	156
Table 4.4-1: Hyper Model Selected Variable Summary.....	157
Table 4.4-2: Structural Model Fit Indices.....	161
Table 4.4-3: Unstandardized Regression Estimates.....	162

Table 4.4-4: Standardized Estimates of 2 nd Revised SE Support – SE Rigor Model.....	163
Table 4.4-5: Goodness of Fit Indices for SE Support-SE Rigor Structural Model.....	164
Table 4.4-6: Direct, Indirect and Total Effects	167
Table 4.4-7: Mediation Effects	169
Table 4.4-8: Hypothesis Testing.....	169

LIST OF ACRONYMS

Acronym	Definition
AESS	Aerospace and Electronics Systems Society
ASE	Agile Systems Engineering
AVE	Average Variance Extracted
BKCASE	Body of Knowledge and Curriculum to Advance Systems Engineering
CFA	Confirmatory Factor Analysis
CFI	Comparative Fit Index
CMMI	Capability Maturity Model Integration
CR	Construct Reliability
CSF	Critical Success Factor(s)
DoD	Department of Defense
DoE	Department of Energy
DOT	Department of Transportation
EFA	Exploratory Factor Analysis
EIA	Electronic Industry Alliance
GFI	Goodness-of-Fit Index
IEC	International Electrotechnical Commission
IEEE	Institute of Electrical and Electronics Engineers
IEEE-CS	Institute of Electrical and Electronics Engineers Computer Society
INCOSE	International Council on Systems Engineering

IRB	Institutional Review Board
ISO	International Organization for Standardization
LSE	Leans Systems Engineering
LSS	Lean Six Sigma
MBSE	Model-Base Systems Engineering
NASA	National Aeronautics and Space Administration
NDIA	National Defense Industrial Association
NRO	National Reconnaissance Office
RMSEA	Root Mean Square Error of Approximation
SE	Systems Engineering
SEBoK	Systems Engineering Body of Knowledge
SEC	Systems Engineering Culture
SEI	Software Engineering Institute
SEMP	Systems Engineering Management Plan
SEP	Systems Engineering Plan
SER	Systems Engineering Rigor
SERC	Systems Engineering Research Center
SES	Systems Engineering Support
TLI	Tucker-Lewis Index
UHF	Ultra-High Frequency
USAF	United States Air Force

CHAPTER I: INTRODUCTION

1.1 Background

Outsourcing of labor has been an effective strategy for many organizations. An organization's decision to outsource may be driven by reasons such as resource limitation, technical capabilities, cost-effectivity, or even convenience. Large and small companies alike outsource from time to time. One of the things that many organizations outsource, is the development of complex systems. This is especially true for the United States Government. The U.S. Government rely heavily on contractors in some way, to develop most, if not all, of their complex systems. The federal government spent over \$20 billion for the development of complex space systems in 2018 ("Consolidated Appropriations Act 2018," 2018).

When contracting out systems development, most organizations go through a bidding process where contractor candidates submit a proposal, bidding on the potential project. In some cases, the contractor would have to meet certain criteria prior to submitting a proposal. Once the qualified proposals are received, the hiring organization evaluates the proposals and selects a contractor. This is a process not only used by many large companies, but also by the federal government. The U.S. Government has one of the most extensive contract evaluation processes. Proposals are examined using three evaluation categories: cost evaluation, past performance evaluation, and technical evaluation (Office of Management and Budget, 2005). The U.S. Government looks at six technical factors when evaluating contract proposals (Office of Management and Budget, 2005):

1. Overall technical approach; proposed methodology; demonstrated understanding of the scope of work and requirements
2. Previous demonstrated production experience and past performance
3. Quality Control

4. Capability and Experience of Key Personnel
5. Project Management and Corporate Support Capability
6. Facilities and Equipment

Five of the 6 technical factors could be considered elements of systems engineering (SE), which will be discussed in detail in Chapter II. If very little or no prior experience exists with the contractor, how can the hiring organization accurately determine the risk associated with the organization that has been contracted to deliver a complex system? Or what is the best way to evaluate whether this criteria is adequately met? These are questions that must be explored.

1.2 Problem Statement

The National Aeronautics and Space Administration (NASA), United States Air Force (USAF), and the National Reconnaissance Office (NRO) all hire contractors to deliver government satellites to orbit. U.S. Government satellite cost can range from \$10 Million to \$10 Billion per satellite (Pawlikowski, 2010), and multiple satellites are launched every year. The purposes of these missions range from science to national security. This is why risk mitigation is imperative, and why these satellites are only entrusted to launch vehicle providers that the Federal government deems worthy. For the purposes of this study, a launch vehicle is considered to be any vehicle that has the capability of delivering a payload to a desired location in space. In 2011, USAF and NRO signed an agreement to follow NASA's launch vehicle risk mitigation policy (USAF, NRO, & NASA, 2011). NASA's launch vehicle risk policy, aims to certify a launch vehicle prior to use for government satellites. Certification is judged based on 13 elements that the contractor's organization and launch vehicle is evaluated on (NASA, 2012). The certification elements are:

- Management Systems
- Flight Experience
- System Design
- Launch Service Contractor Design Reliability
- Manufacturing & Operations and System Engineering
- System Safety
- Test and Verification
- Quality Systems/Process
- Flight Hardware & Software Qualification
- Launch Vehicle Analysis
- Risk Management
- Integrated Analysis
- Launch Complex

The launch vehicle certification policy has been in place for over 15 years and largely remained unchanged during that time. In 2012, one of the more significant changes were made to the launch vehicle certification policy. The addition made in 2012 was to evaluate the launch vehicle provider's systems engineering. Even though many of the certification elements have components of systems engineering such as: Management Systems, System Design, Manufacturing & Operations, System Safety, Test & Verification, Flight Hardware and Software Qualification, Launch Vehicle Analysis, Risk Management, and Integrated Analysis, there was nothing in the policy to enforce specifically evaluating system engineering prior to 2012.

Before continuing this discussion, it would be helpful to define systems engineering. Systems engineering has been defined by many as a methodical interdisciplinary approach to design, build, operate, manage, and retire a system, where these systems must meet stakeholder requirements (BKCASE Editorial Board, 2014; Brill, 1999; INCOSE, 2011; NASA, 2007). Based on how systems engineering is defined, it is germane to the process of developing a complex system such as a launch vehicle. The system engineering element was added to the NASA's certification policy, because NASA believes that since systems engineering affected almost every element of a launch vehicle's ability to be successful, that it was imperative to evaluate as part of risk mitigation. NASA's systems engineering concerns with launch vehicle success was corroborated by several independent researchers, which is discussed in detail in Chapter II. Even though NASA believes it is necessary to evaluate a launch service provider's systems engineering, there is currently no existing framework for evaluating the systems engineering of launch vehicle organizations.

The commercial space industry face similar launch vehicle risks that the Federal government has to contend with. The cost of a launch failure that results in a loss of spaceflight crew, satellite, or launch vehicle has a significant impact on economic viability of the launch vehicle (Sauvageau & Allen, 1998). A launch failure would not only have a significant effect on the launch vehicle provider but could also negatively impact the commercial satellite owner. Commercial satellites are used in everyday life for things such as communication, television broadcasts, internet, navigation, and weather forecasting. A launch failure resulting in the loss of a commercial satellite could have a significant impact on the commercial company's business operations and the U.S. economy (Gydesen, 2006).

In 2001, J. Steven Newman performed a study at NASA, that evaluated 50 space systems failures and found that all 50 failures can be attributed to errors or deficiencies in the system engineer process (Newman, 2001). In the study, 41 of the 50 space systems evaluated by Newman were launch vehicles.

Newman’s study underscores the need to understand the factors effecting systems engineering in launch vehicle organizations.

1.3 Hypothesis

One of the keys to understanding a launch vehicle organization’s ability to successfully complete a mission, is to understand some of the factors effecting the organizations systems engineering practices. There have been several studies that link systems engineering deficiencies to launch vehicle failures. The relationship between systems engineering deficiencies and launch vehicle failures is discussed in detail in Chapter II. This study seeks to understand factors effecting systems engineering and that could potentially lead to systems engineering deficiencies. By studying the factors effecting the implementation of systems engineering, one could gain insight in to the risk associated with a launch vehicle’s organization ability to successfully complete a mission. To test the structural relationships between the constructs identified in this study, the hypotheses identified in Table 1.3-1 were developed. The constructs of the hypotheses are described in detail in Chapter II and what the constructs can indicate is described in Chapter III.

Table 1.3-1: Research Hypotheses

H ₁	Systems engineering culture has a direct effect on systems engineering rigor.
H ₂	Systems engineering support has a direct effect on systems engineering rigor.
H ₃	Systems engineering culture has a direct effect on systems engineering support.
H ₄	Systems engineering support will mediate the relationship between systems engineering culture and systems engineering rigor.

In order to determine the factors effecting systems engineering in a launch vehicle organization, several questions have to be answered. These research questions are the motivation and drivers for

performing this research. They identify specific problems to study. These questions also provide guidance for the types of data to be collected and how to analyze and interpret the data (Leedy & Ormrod, 2013). The main (primary) research questions is as follows:

“What are the effects of systems engineering culture and systems engineering support on systems engineering rigor in launch vehicle organizations?”

The secondary questions that are used to guide the literature review that provide necessary information in addressing the primary questions are:

- *What factors effect systems engineering in an organization?*
- *How does launch vehicle organizations implement their systems engineering?*
- *How does systems engineering effect launch vehicle failures?*
- *What are systems engineering best practices?*
- *What are the critical factors for implementing systems engineering?*
- *Who is involved in implementing systems engineering?*
- *What are the enablers of systems engineering?*
- *What guidelines are used to implement systems engineering?*
- *What systems engineering models are currently being used?*

1.4 Research Objectives

Systems engineering deficiencies have been linked to numerous launch vehicle failures. There has been little focus on looking at the underlying factors that affect systems engineering deficiencies. Launch vehicle failure investigations have looked at general organizational causes, however not specific to systems engineering. The main objective of this research is to enhance and build a strong systems

engineering culture and support system to reduce launch vehicle failures and improve reliability. The purpose of this research project is to develop the framework that could be used to evaluate systems engineering culture and support in launch vehicle organizations. The model identifies the relationship of systems engineering culture and systems engineering support on launch vehicle problems and systems engineering rigor.

1.5 Research Limitations

Identifying the research limitations is important for establishing the boundaries of the research. For this study, launch vehicle organizations within the United States will be examined. In addition, correspondence with U.S. organizations is more practical and language barriers would not be a factor. The data available for this study will come from the launch vehicle industry, which includes both government and private organizations. There are numerous variations of systems engineering models, so to keep the study focused, the study will concentrate on the most frequently used SE (systems engineering) models. Limiting the study to the most frequently used SE model types is done to define appropriate boundaries for the study. However, results can be generalized to most SE models used in the aerospace industry.

1.6 Definition of Terms

Table 1.6-1: Definition of Terms

Term	Definition
Metric	A standard of measurement of a process
Organization	Any entity that is tasked to develop a system. This can be a private company, a non-profit organization, or a government agency.
System	For the purposes of this study, a system is defined as a collection of elements that work together to produce a result not achievable by an individual element alone. These elements can include hardware, software, processes, people, information, facilities, or anything that supports the elements (BKCASE Editorial Board, 2014; INCOSE, 2011; Maier & Rechtin, 2009; Nicholas & Steyn, 2012).
Systems Engineering	Systems engineering is an interdisciplinary approach to enable the realization of successful systems. The approach focuses on holistically and concurrently identifying and understanding stakeholder needs; identifying requirements; and synthesizing, verifying, validating, deploying, sustaining and evolving solutions while considering the complete problem, from system concept exploration through system disposal. (BKCASE Editorial Board, 2014; INCOSE, 2011)
Systems Engineer	A practitioner of systems engineering as defined above
Systems Engineering Best Practices	Approaches or behaviors widely accepted by the systems engineering community as good things to implement during the systems engineering process
Systems Engineering Culture	The systems engineering values, beliefs, and normal practices of an organization (Carroll, 2016; Iivari & Huisman, 2007; NASA, 2003; SEBoK authors, 2016)
Systems Engineering Support	The tools, infrastructure, and resources used to aide, implement, or enforce the systems engineering process
Systems Engineering Rigor	Level of rigor in applying established systems engineering process and principles

1.7 Assumptions

Leedy and Ormrod (2013) states that an assumption is a condition that the value of which is often underestimated, and without this condition, the research would be pointless. Assumptions in research are tantamount to axioms in geometry (Leedy & Ormrod, 2013). Leedy and Smith (2013) also identified two assumptions that can be implied in almost all research, (1) the phenomenon under investigation is not composed of completely random events and can be predicted, and (2) certain cause-and-effect relationships can account for patterns observed in the results of the research. These two assumptions apply to this study as well. Specifically, the major assumption of this study is that identifying the relationship between systems engineering culture, support, and rigor can be accomplished. Another assumption of this study is that the results of the surveys that have been received accurately reflects the launch vehicle industry population.

1.8 Significance of Study

Launch vehicle failures is a constant concern in the launch vehicle industry. Several studies show that numerous launch vehicle failures could be attributed to systems engineering failures. This concern with launch failures led to government organizations' desire to evaluate the systems engineering of launch vehicle providers. The results of this study can be used to improve the ability to evaluate the systems engineering of launch vehicle organizations. Although the population of the study will come from the launch vehicle industry, the results should be applicable to any organization that develops a highly complex system and are therefore generalizable. Results from any survey or empirical data collected as part of this study can also be generalizable and applicable to any organization that applies SE.

Identifying underlying factors that influence systems engineering rigor in a launch vehicle organization has a variety of uses. These factors could allow launch vehicle customers to appropriately

evaluate the risk of using a particular launch vehicle provider. Understanding these factors also would provide organizations looking to outsource the development of a system framework to evaluate the system development practices of the contractor. This will in turn allow the contracting organization to adequately determine the risk of using a particular contractor. Assessing the risk of a developer is especially crucial when complex, critical, or costly systems are being developed. These systems engineering relationship factors would be useful in the contractor proposal phase as well, by aiding in evaluating the proposal, as well as auditing the contractor before and after a contract is awarded.

CHAPTER II: LITERATURE REVIEW

This literature review will seek to identify answers to the research questions or identify gaps by examining the following areas:

- Foundation of Systems Engineering
 - Value of Systems Engineering
- Traditional Systems Engineering Approaches
- Recent Systems Engineering developments/approaches
- Systems Engineering Best Practices and Standards
- Systems Engineering Metrics
- Assessing Systems Engineering Practices
- Critical Success Factors of Systems Engineering
- Systems Engineering association with Launch Vehicle Failures

2.1 Methodology of Review

For this literature review, a scientific approach has been implemented. The scientific method has been adopted as a guideline to determine which literature has been selected as part of this review. To qualify for this literature review, the literature must answer one of the following questions positively:

1. Does it describe or identify the factors that influence systems engineering in an organization?
2. Does it describe or identify systems engineering best practices or methodology?

3. Does it identify any systems engineering lessons learned?
4. Does it provide information on the value or usefulness of systems engineering?
5. Does it describe how to implement systems engineering?
6. Does it provide information on the critical success factors of systems engineering or related fields?
7. Does it describe how to assess systems engineering in an organization?
8. Does it describe how systems engineering is associated with launch vehicle failures?

The majority of the literature that was chosen has come from peer reviewed journals. The range of the dates of the research literature that has been chosen has been from 1985 and 2018, with the vast majority of the literature coming from the 2004 – 2016 timeframe.

2.2 Foundation of Systems Engineering

Before diving into the factors that influence systems engineering in organizations, it would be useful to understand the history of systems engineering and the background of the concept. For many years, the International Council on Systems Engineering (INCOSE) has been one of the global leaders in identifying and developing Systems Engineering standards, best practices, and is considered by many to be the authority on systems engineering. In 2009, INCOSE joined with two other influential systems engineering organizations, the Systems Engineering Research Center (SERC) and the Institute of Electrical and Electronics Engineers Computer Society (IEEE-CS), to create a project called the Body of Knowledge and Curriculum to Advance Systems Engineering (BKCASE). BKCASE created what has come to be known by many as the systems engineering encyclopedia, called the Guide to the Systems Engineering Body of Knowledge (SEBoK). The purpose of the SEBoK was to create a globally accepted

collection of systems engineering practices and knowledge that is regularly updated (BKCASE Editorial Board, 2014). The SEBoK has proven to be a valuable systems engineering resource for understanding the foundations and history of systems engineering.

The origins of the systems engineering concept as we know it, can be traced back to the post-World War II time period (BKCASE Editorial Board, 2014; M. Emes, Smith, & Cowper, 2005; INCOSE, 2011). INCOSE and BKCASE mention a few isolated events that occur prior to World War II, but none of the events identified systems engineering as a discipline. It wasn't until after World War II when the term "systems engineering" came about. None of the literature appears to agree on one specific event or date, however all agree that systems engineering discipline has its origins in the post-World War II time period.

Bell Laboratories, in the 1940s, was the first to use the term "systems engineering" during its work on the Nike line-of-sight anti-aircraft missile system for the U.S. Army (Brill, 1999; INCOSE, 2011). Following this time period, during the 1960s, there were a few individuals and organizations that wrote about systems engineering, however the USAF was the first organization to publish a comprehensive series of systems engineering documents. The USAF documents that were published, detailed the systems engineering process. This began the push for the defense industry, and its many complex systems, to practice systems engineering. With the growing complexity, dynamism, and scale of systems being developed, by the 1990s the need for systems engineering grew more than ever. In 1992, the USAF published the *Systems Engineering Handbook*, which was a comprehensive description of systems engineering and systems engineering management, including a template for a Systems Engineering Management Plan (SEMP). That same year, INCOSE was founded to develop and disseminate systems engineering principles and practices and would later go on to publish a systems engineering handbook of their own. In 1995, NASA would published the NASA Systems Engineering

Handbook. The systems engineering principles developed by USAF, INCOSE, and NASA in the early 1990's became the foundation of what is not considered traditional systems engineering.

2.3 Value of Systems Engineering

There are many that question about the importance of or value of systems engineering. After all, a lot of complex projects were completed before “systems engineering” was established. The defense industry realized how important SE was and invested a lot of resources into developing the discipline. However, many engineers and managers have disputed the value of SE. Due to this dispute, there have been studies performed to provide quantitative evidence on the impact of systems engineering.

The National Defense Industrial Association (NDIA) has been the leader in studying the effectiveness of systems engineering. NDIA completed SE effectiveness studies in 2008 and 2012 in conjunction with IEEE Aerospace and Electronics Systems Society (AESS) and the Software Engineering Institute (SEI) of Carnegie Mellon University (Elm, 2012; Elm & Goldenson, 2012; Elm et al., 2008). INCOSE also performed a SE Effectiveness study of their own in 2004 (Eric C. Honour, 2004; Vanek, Jackson, & Grzybowski, 2008). Research studying the value of SE were also done by a few other researchers such as Werner Gruhl, Joseph Elm, and Eric Honour. Most SE researches have stated, the difficulties with performing an SE effectiveness study, is to effectively isolate the effect of SE from other effects and the limited amount of information about a particular project that can be published. Another concern with this type of study is the divergence in SE definitions (Eric C. Honour, 2010). The following is a summary of the studies on SE effectiveness found during the literature search:

1. The study completed by Gruhl at NASA was one of the first studies to understand the effects of SE on a project. Gruhl's study examined the relationship between the investment on SE to the NASA program cost overrun (BKCASE Editorial Board, 2014) demonstrates the value of SE, as seen in Figure 2.3-1. Gruhl's analysis provided the first

quantitative data that shows how systems engineering affects a project. It showed the relationship of systems engineering effort and project quality by comparing the cost overrun of 32 major NASA projects with cost spent on systems engineering activities (Gruhl, 1992; Eric C. Honour, 2004). Gruhl's analysis has since been used by many. In most of the literature reviewed, researchers such as Eric Honour, Joseph Elm, Francis Vanek, and INCOSE, to show the value of systems engineering.

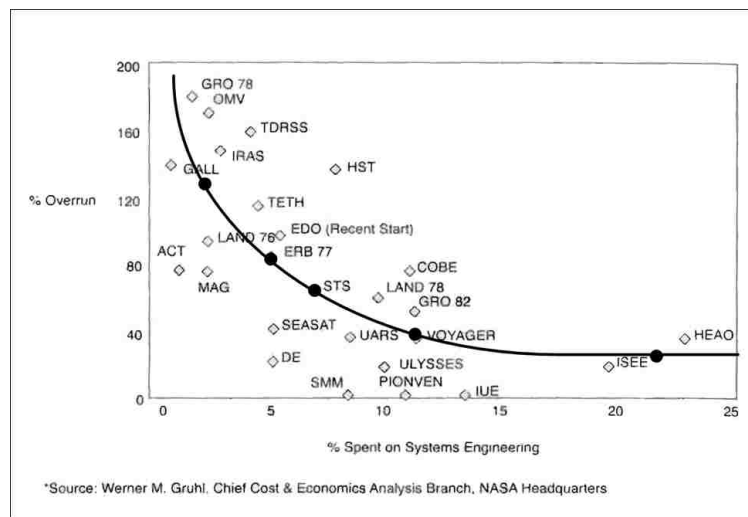

Figure 2.3-1: Program Budget Overrun vs Money Spent on Systems Engineering

2. In the early 90s, Boeing performed a study on the development of three Universal Holding Fixtures (UHF). UHF1 was completed without using any SE practices. UHF2 and UHF3 were completed using SE best practices. Both UHF2 and UHF3 were completed in less than half the time of UHF1, and UHF3 was the most complex of the three (Eric C. Honour, 2004; Vanek et al., 2008).

3. As quoted by Francis Vanek in *SE Metrics and Applications in Product Development*, in 1996, Kamal Malek completed a study on automobile proto-type development. Malek found that prototypes were developed much faster than normal when a close relationship was established between the manufacture's development team and engineering teams of the suppliers. This was accomplished by collocating engineering teams, which increased communication amongst the teams. This allow collaboration amongst the manufacturing and supplier teams early in the design life cycle (Vanek et al., 2008).
4. In 2004 Kludze conducted a survey of NASA and INCOSE members that included 46 of the top engineering firms in the world such as: Lockheed Martin, Canadian Space Agency, Motorola, Northrop Grumman, Ford Motor Company, Corning, Airbus, Boeing, IBM, Swales Aerospace, just to name a few. Results of the survey showed that the majority of the respondents indicated that they saw a reduction in cost when systems engineering was applied (Kludze, 2004).
5. Eric Honour, former president of INCOSE, has done extensive studies on the value of SE. Honour's first study examined the heuristic value of SE. Honour identified six systems engineering qualities in which to evaluate a project's SE practices such as: cost, schedule, technical value, technical size, technical complexity, and technical quality. Honour's study showed that SE improves development quality, optimum SE effort is 15-20% of the total project effort, and that the quality of the SE mattered (Eric C. Honour, 2004). Honour's second study focused on SE return on investment and focused on eight SE activities: mission definition, requirements engineering, systems architecting, system implementation, technical analysis, technical management, scope management, and verification & validation. The second study showed the significance/effect of each

individual SE activity. The study provided quantifiable data that showed the relationship between SE effort and program success (Eric C. Honour, 2010).

6. The more recent and significant study was completed by NDIA in conjunction with IEEE-AESS and SEI, led by Joseph Elm. In this study, system developers were surveyed to identify SE best practices, collected performance data on their projects, and then determined the relationships between the application of SE best practices and performance of the project (Elm, 2012; Elm & Goldenson, 2012). The results of the study showed that there are clear and significant relationships between SE best practices and project performance. Project performance was measured on meeting budget, schedule, and technical performance. Results of the study showed that when low level of SE best practices were applied, more than half of the projects showed low performance. When high level of SE best practices were applied, more than half of the projects showed high performance (Elm, 2012; Elm & Goldenson, 2012).

All though the research that was conducted in the literature that was reviewed, studied different programs, employed different methods, and examined different aspects, all agree that the value of systems engineering can be seen in cost, schedule, and technical performance (BKCASE Editorial Board, 2014; Elm, 2012; Eric C. Honour, 2004, 2010; INCOSE, 2011; NASA, 2007). Programs that apply SE best practices are better at meeting cost, schedule, and technical performance. These studies show evidence that there is value in using SE best practices. However, there are many that argue that there still is insufficient quantifiable data to justify the return on investment in SE. Many studies have shown most of the world's leading developers of complex systems practice systems engineering and believe that SE is important to developing a complex system. One could draw the conclusion that the industry standard for developing a complex system is employing some form of systems engineering. There may be detractors that say, "Just because everyone is doing it doesn't mean that SE is useful." It's not the fact that the

leading developers of complex systems employ systems engineering, it's that the world leading complex system developers have had success using SE and believe that practicing SE is important to the successful development of a complex system.

2.4 Systems Engineering Concepts

There are many different approaches to systems engineering that was found in the literature that was reviewed. Each approach had its own merit. The majority had the same underlying concepts and themes. The main concepts of systems engineering that have been identified in the literature reviewed from NASA, INCOSE, BKCASE, Emes, and Tremaine, are:

Systems Thinking

Holistic Lifecycle View (Systems Engineering Lifecycle)

(BKCASE Editorial Board, 2014; M. Emes et al., 2005; INCOSE, 2011; NASA, 2007; Nicholas & Steyn, 2012; Tremaine, 2009).

2.4.1 Systems Thinking

These concepts are the main drivers behind the SE engine. Systems thinking is described by Nicholas and Steyn as “being able to perceive the ‘system’ in a situation, to take a seemingly confused, chaotic situation and perceive some degree of order or harmony in it” (Nicholas & Steyn, 2012). The ability to look at a system components and look at it as a whole organism, seeing how one component affects another is considered systems thinking. (BKCASE Editorial Board, 2014; Nicholas & Steyn, 2012). This skill is essential to systems engineering (Smartt & Ferreira, 2010).

2.4.2 Holistic Lifecycle View

The Holistic Lifecycle (M. Emes et al., 2005) is also called the Systems Engineering Life-Cycle (BKCASE Editorial Board, 2014; INCOSE, 2011; NASA, 2007). The systems engineering life-cycle that has been identified in the majority of the literature reviewed consists of 7 phases:

1. Exploratory Research
2. Concept
3. Development
4. Production
5. Utilization
6. Support
7. Retirement

(BKCASE Editorial Board, 2014; Blair, Ryan, & Schutzenhofer, 2011; Brill, 1999; M. Emes et al., 2005; Jansma, 2010; NASA, 2007; Nicholas & Steyn, 2012; Pennell & Knight, 2005). Although the naming of each phase or the number of phases may differ slightly in the literature that was reviewed, all agree on these phases in some form and the elements that compose the holistic life-cycle. Figure 2.4-1 below illustrates the logic model for a generic systems engineering life cycle.

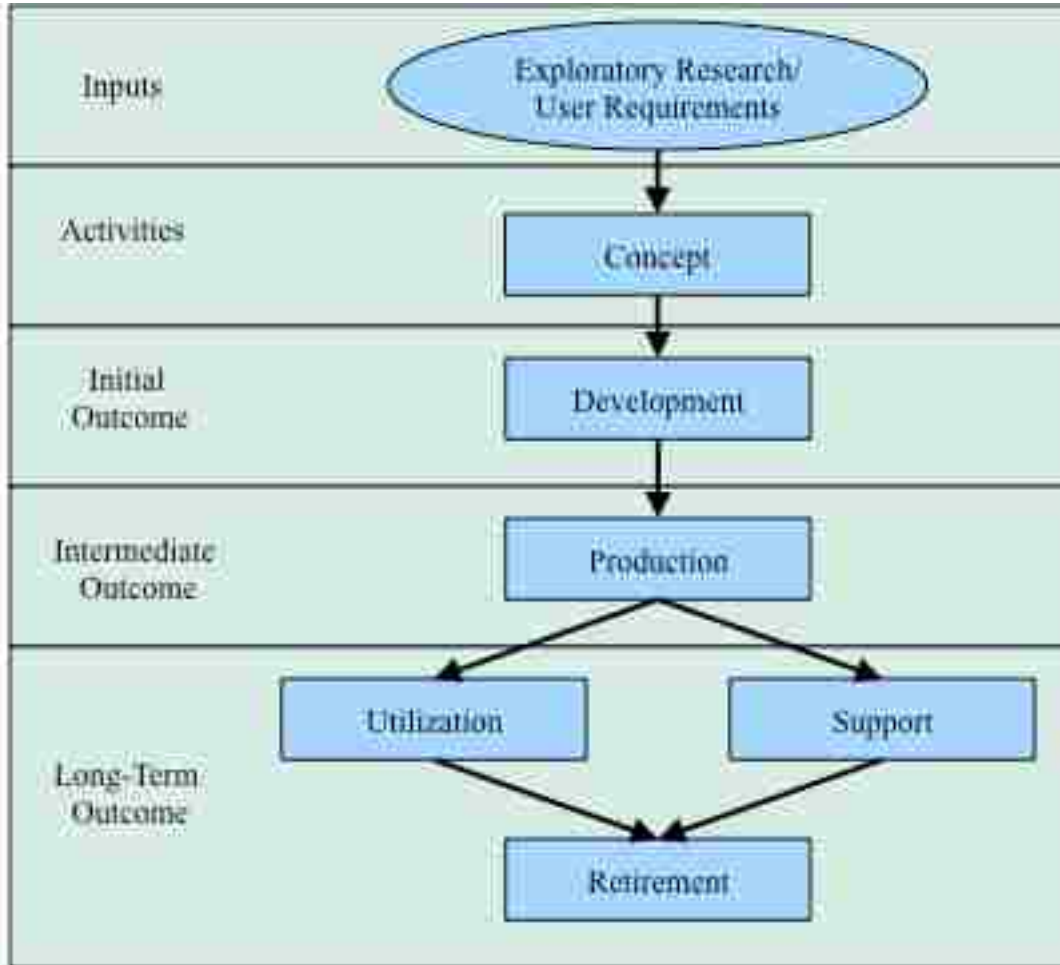

Figure 2.4-1: Logic Model for Generic Systems Engineering Life-Cycle

2.4.2.1 Exploratory Research

This is the beginning phase of the SE life-cycle. Studies are done during this phase to explore new ideas, capabilities, and technologies. User requirements analyses are also performed during exploratory research. Feasibility studies are performed to determine if user requirements could be met based on current technology (NASA 2007, INCOSE 2011). Requirements developed during this phase are considered top-level requirements.

2.4.2.2 Concept Phase

During the concept phase, feasibility studies are done to determine best solutions to meet stakeholder's needs. Refinement and broadening of studies and engineering models are done as well. Candidate concepts are evaluated during this phase. This concept phase is the preparation to begin development

2.4.2.3 Development Phase

The development phase is considered by many to be the most critical phase of systems engineering, this is why a lot of research has been concentrated in this area of the systems engineering life-cycle. This phase's activities include planning, developing, and verification & validation activities. This initial phase in the SE life-cycle is the phase in which requirements are developed for the project. Numerous studies have shown that poor requirements development are the most costly, and can lead to cost overruns, project not being on schedule, and poor technical performance (Bijan, Yu, Stracener, & Woods, 2013; BKCASE Editorial Board, 2014; Blair et al., 2011; Gruhl, 1992; Head & Virostko, 2009; Eric C. Honour, 2010; INCOSE, 2011). However, requirement mistakes caught during this phase of the SE life-cycle are less expensive to fix, than requirement mistakes caught in later phases.

The requirements development or decomposition, which takes place during the Development Phase, is also the area where SE practitioners differ in requirements philosophy. Requirements development approach can vary based on the systems architecting model approach such as waterfall (traditional approach), spiral, incremental, and agile. Some researchers argue that there is no real difference between systems engineering and systems architecting and that a consensus on the definition of systems architecting has yet to be reached (M. R. Emes et al., 2012). For the sake of this literature review, we will look at the relationship of systems architecting and systems engineering similar to how the relationship of architects and civil engineers are viewed. There is a lot of overlap between the two,

but systems architecting is more of art and systems engineering is more focused on science and heuristics. Each systems architecting approach has its pros and cons and their uses vary by industry and project (Maier & Rechtin, 2009). For example, in the space industry a waterfall architecting approach may be preferred (NASA, 2007; Pennell & Knight, 2005), where as in the software industry, an iterative, or agile approach may be preferred (Maier & Rechtin, 2009). The different systems architecting approaches or SE models will be discussed in detail in later sections of this literature review.

2.4.2.4 Production Phase

This is the phase where systems designs are finalized and the systems is built, inspected, integrated, and tested. Once the hardware begins to be fabricated, the system designers may come across manufacturing issues that may require modification of the hardware. This may require re-verification and re-validation of the system. These issues should be resolved during this phase. At the completion of the production stage, the hardware should be ready for customer use. (BKCASE Editorial Board, 2014; INCOSE, 2011; SEBoK authors, 2016)

2.4.2.5 Utilization Phase

The Utilization Phase is also called the Implementation Phase (NASA, 2007), Production and Execution Phase in some literature (BKCASE Editorial Board, 2014; INCOSE, 2011), and Operations in others. Throughout this phase verifications to system requirements are made (Sage & Lynch, 1998). With the complexity of today's systems continuing to increase, system integration has continued to become more of a concern (Madni & Sievers, 2014). The naming convention for the intermediate steps vary in the literature reviewed, however, the types of task that are performed in this phase is consistent throughout the literature reviewed (BKCASE Editorial Board, 2014; INCOSE, 2011; Madni & Sievers,

2014; NASA, 2007; Nicholas & Steyn, 2012). System requirements errors found during this phase of the SE life-cycle have proven to be most costly (BKCASE Editorial Board, 2014; Gruhl, 1992; Eric C. Honour, 2004, 2010; Nicholas & Steyn, 2012).

2.4.2.6 Support Phase

During this stage, the system of interest is providing its intended function and continued operation. Modifications may be proposed to resolve supportability issues.

2.4.2.7 Retirement Phase

In this stage, the system is removed from operation. The primary focus of this stage is ensuring that the requirements for disposal are being met.

2.5 Traditional Systems Engineering

For the purposes of this literature review, a traditional systems engineering would be described as the SE approach that was developed and refined during the time period of the “systems engineering revolution”. This time period can be considered loosely to be from 1960 to 1990. The U.S. government was heavily involved in developing the traditional approach, since it was the US government was one of the largest developers and buyers of large complex systems. The DoD and NASA also performed numerous studies during this time to refine SE approaches. Two approaches that came out of the “systems engineering revolution” are the Waterfall model, and Vee Model.

2.5.1 Waterfall

Waterfall is a plan-driven approach and is considered traditional systems engineering. It is described as a waterfall due to its sequential steps in system development. In the waterfall approach, the project is divided into sequential phases (Balaji & Murugaiyan, 2012; INCOSE, 2011). Each phase of the waterfall must be completed before moving on to the next phase. The waterfall approach satisfies each stage of the generic SE approach. There may be some overlap of the phases. The Waterfall model can be seen below.

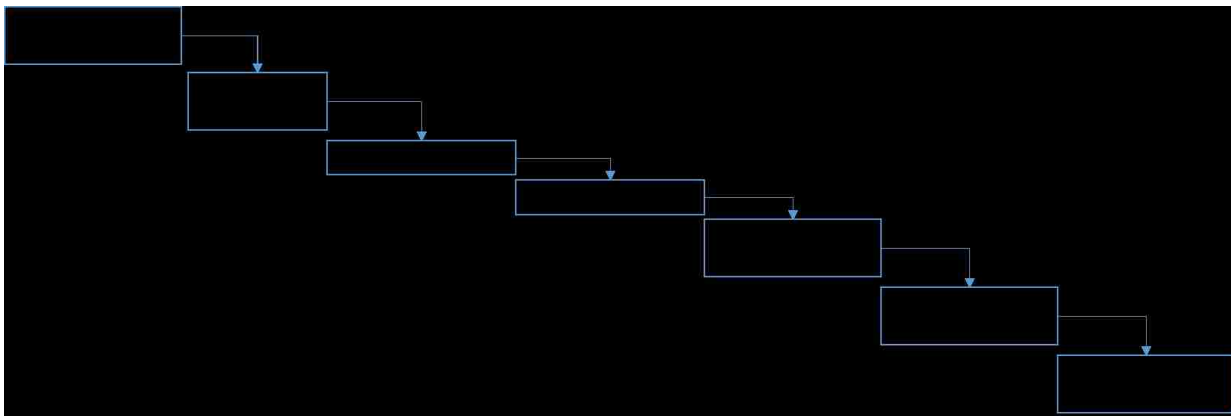

Figure 2.5-1: Waterfall Model

The benefits of the Waterfall approach, is that (Balaji & Murugaiyan, 2012):

- Requirements are clear before development begins.
- A phase is completed in specified period of time, so the next phase begin
- It is easy to implement.
- Requires minimal resources to implement.
- Each phase adequately documented and is followed to ensure the quality of the system development.

This approach is beneficial to the government because it focus on requirements being clear up front and it provides natural milestones where approval gates can be implemented. A highly planned driven approach is also preferential when dealing with a large number of organizations coordinating to develop a large complex system. Dividing up the development of a system amongst a number of organizations is often the case with government projects.

2.5.2 Vee

The Vee model is very similar to the waterfall. Like the Waterfall, the Vee is considered a traditional systems engineering approach and is plan-driven. However, in the Vee, the sequence is turned back up (hence Vee) and connects testing to each phase of development (Balaji & Murugaiyan, 2012; BKCASE Editorial Board, 2014; INCOSE, 2011). In the Vee, development and testing can be done in parallel. The Vee model is illustrated below.

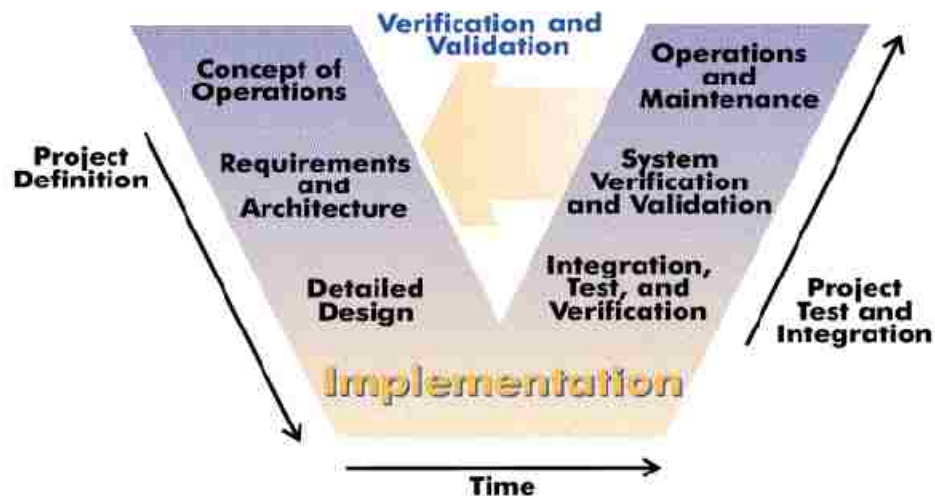

Figure 2.5-2: Vee Model

Source: <http://en.wikipedia.org/wiki/V-Model>

The benefits of the Vee approach, is that (Balaji & Murugaiyan, 2012):

- Requirements are clear before development begins.
- A phase is completed in specified period of time, so the next phase begin
- It is easy to implement.
- Requires minimal resources to implement.
- Each phase adequately documented and is followed to ensure the quality of the system development.
- Testing and verification is performed at each phase of development to ensure the system is meeting requirements at every phase
- Although not desired, requirements changes are possible at every phase

Similar to the Waterfall model, Vee model approach is beneficial to the government because it focus on requirements being clear up front and it provides natural milestones where approval gates can be implemented. As already stated, planned driven approach is preferential when dealing with a large number of organizations coordinating to develop a large complex system. Unlike the Waterfall model, requirements changes are possible at any phase, and requirements changes are sometimes unavoidable.

2.6 Recent Systems Engineering Approaches

Thus far in this literature review, what has been discussed was traditional systems engineering. The traditional systems engineering methodology was developed in the later part of the twentieth century. Since then, there have been new additions and variations of the systems engineering methodology. In this

section, we will discuss a more recent systems engineering approaches. Some of the recent development of systems engineering includes:

- Lean Systems Engineering
- Agile Systems Engineering
- Model-Based Systems Engineering

2.6.1 Lean Systems Engineering

Lean Systems Engineering (LSE) is a marriage of Systems Engineering and Leans Six Sigma (LSS) (Snee, 2010). LSE is the application of lean thinking to systems engineering (BKCASE Editorial Board, 2014; INCOSE, 2011; Oppenheim, Murman, & Secor, 2011). We have already discussed what systems engineering is, thus literature had to be reviewed to understand Lean Six Sigma. There has been extensive research performed on Lean Six Sigma and its parent, Six Sigma. Since this literature review is focused on Systems Engineering, only a limited literature review on Lean Six Sigma was performed, to get an adequate understanding of how Lean Six Sigma relates to Lean Systems Engineering.

The Six Sigma is a concept for continuous business improvement. It was developed in the late 80's by Motorola (Snee, 2010; Welo, Tønning, & Rølvåg, 2013). Lean manufacturing was a manufacturing concept of only maintaining what adds value and reducing everything else, was developed by Toyota in the late twentieth century (Welo et al., 2013). In the early 2000s, lean manufacturing concepts was integrated into Six Sigma, strengthening the approach allowing improvements to be identified much faster of the traditional Six Sigma approach. The newly formed Lean Six Sigma became a methodology to systematically improve process performance that would result in customer satisfaction

improve profit. Some of the major principles of Lean Six Sigma are (Evans & Lindsay, 2014; Snee, 2010; Tremaine, 2009; Welo et al., 2013):

- Focus on the customer - Understand value as the customer defines it
- Plan the value added tasks and eliminate waste
- Plan only value added tasks and streamline – adding steps and processes, without idle time, unplanned rework, or backflow
- Pursue perfection of all processes

The major concept of Lean Six Sigma is “lean thinking”. Lean thinking is considered to be the dynamic, heuristic, knowledge driven, customer-focused process through which all stakeholders in a defined organization continuously eliminate waste with the goal of creating value (BKCASE Editorial Board, 2014; INCOSE, 2011; Oppenheim et al., 2011).

Studies done by the Department of Defense shows that practitioners of Lean Six Sigma and Systems Engineering have many practices in common: Such as (Tremaine, 2009):

- Systems thinking. Similar to how a Systems Engineer would view the Anti-aircraft missile weapons systems he is developing; the Lean Six Sigma practitioner views the organization he or she is trying to improve.
- Carefully assess requirements and appropriately decompose them
- Guide and unify interdisciplinary teams
- Evaluating key processes
- Employing analysis, control and performance tracking tools
- Leveraging experience to solve problems

- Influence performance outcomes
- Implement only necessary actions

“So, what do you get when you mix together SE and LSS professionals... you get a comprehensive multidisciplinary collaboration team. You get a natural blending of two camps with exceptional, unifying, and many common functional competencies. You get a profitable merger of two camps steeped in disciplined yet creative problem solving processes. You get a far-reaching problem prevention that can jointly mitigate design, production and fielding issues – early.” (Tremaine, 2009).

With natural overlapping of the principles and skills of LSS and SE, the marriage of the two concepts was almost inevitable. Lean Systems Engineering allows for more and better SE with higher responsibility, authority, and accountability, leading to better, waste-free workflow with increased mission assurance. The goal of Lean SE is to deliver the most life-cycle value for a complex system with minimal waste (BKCASE Editorial Board, 2014). Under the Lean SE philosophy, mission assurance is non-negotiable, and any task that is legitimately require for success must be include, but it should be well planned and executed with minimal waste (INCOSE, 2011). Under LSE, lean engineering is relevant to all of the traditional SE technical processes (BKCASE Editorial Board, 2014; INCOSE, 2011; Oppenheim et al., 2011). The principles of Lean SE are (BKCASE Editorial Board, 2014):

- Stakeholder value-based system definition
- Accountability and Incremental commitment
- Concurrent System definition and development
- Decision making based on evidence and risk

Lean SE attempts to minimize over-processing, waiting, unnecessary movement, over-production, transportation, inventory, and defects. When applied to the systems engineering life-cycle, it attempts to reduce, prevent, or eliminate the following:

- Number of handoffs of products
- Unnecessary serial production
- Excessive reforming or formatting
- Wait time
- Lack of direct access
- Creation of unnecessary products
- Communication issues
- Overstock of inventory
- Outdated information
- Defects

If these lean principles were applied to a traditional systems engineering approach, such as a waterfall, it would no longer look like a waterfall. Many steps would no longer be sequential, and a lot of the formal products and wait times would be eliminated.

2.6.2 Agile Systems Engineering

In recent years, the software industry has realized due to rapid changes in the software world, that a traditional systems engineering approach may not be favorable. The orderly, hierarchical progression through system development, followed by a corresponding verification sequence could be a hindrance. Recognizing that the development process would require more flexibility, the software engineering community collaborated and developed a tailored systems engineering approach to address

the inflexibility of a traditional systems engineering approach (Schapiro & Henry, 2012; Stelzmann, 2012; Stelzmann, Kreiner, Spork, Messnarz, & Koenig, 2010). In 2001, the world leaders in rapid software development gathered and created, which has become the foundation of rapid software development around the world, *The Manifesto for Agile Software Development*. A summary of the principles identified in the manifesto is below (Beck et al., 2001; Frey & Valencia, 2010; Huang, Knuth, Kreuger, & Garrison-Darrin, 2012; INCOSE, 2011; Stelzmann et al., 2010; Turner, 2007):

- Strong customer focus, with early and continuous involvement with customer in product development
- Requirements changes embraced and manage throughout all stages of development
- Frequent delivery of incremental and useful products
- Development teams should be motivated teams that cooperate closely and exchange information and ideas face-to-face regularly
- Ownership of the development team of the product and processes
- Functional product updates achieved through test-driven development is the primary measure of success

These principles are the foundation of agile software development as well as Agile Systems Engineering (ASE). Many concerns arise from adopting the agile software development principles into systems engineering. The primary concern is the integration of hardware. Since hardware is the major difference between software engineering and systems development. Including hardware into agile development accelerates the increases in cost of changes as the system is being developed. This issue is one of the primary reasons why traditional systems engineering was developed – to avoid late changes

(Frey & Valencia, 2010). However many are starting to see the benefits that agile systems engineering will bring, such as flexibility, faster development times, potentially lower costs, and longer shelf lives.

When it comes to Agile SE, the main difference between hardware and software is that hardware is difficult to develop in small cyclical steps. However, research done by Ernst Stelzmann at the University of Technology, shows that agile systems development can be appropriate for the right hardware (Stelzmann, 2012; Stelzmann et al., 2010). Stelzmann's research shows that when hardware prototyping can be done quickly and cheaply, agile systems engineering is feasible. Additionally, customer willingness to support this type of approach, market dynamism, level of innovation, and rate of change were also important factors for the use of agile system engineering in hardware development (Stelzmann, 2012; Stelzmann et al., 2010).

Research done by Stelzmann et al, surveyed companies that are practicing ASE and found four main principles (Huang et al., 2012; Stelzmann et al., 2010):

- The developers are just as, if not more important than the process itself. Process is often more cared about than the people performing the process. The developers are the brainpower and are doing the work. It is wise to consider the process such that the developer can do their job in the best way.
- Incremental development with close customer interaction
- Iterative development increments
- The product and processes should have a flexible design

Based on the research completed by Stelzmann et al, the Agile Systems Engineering Model is as follows:

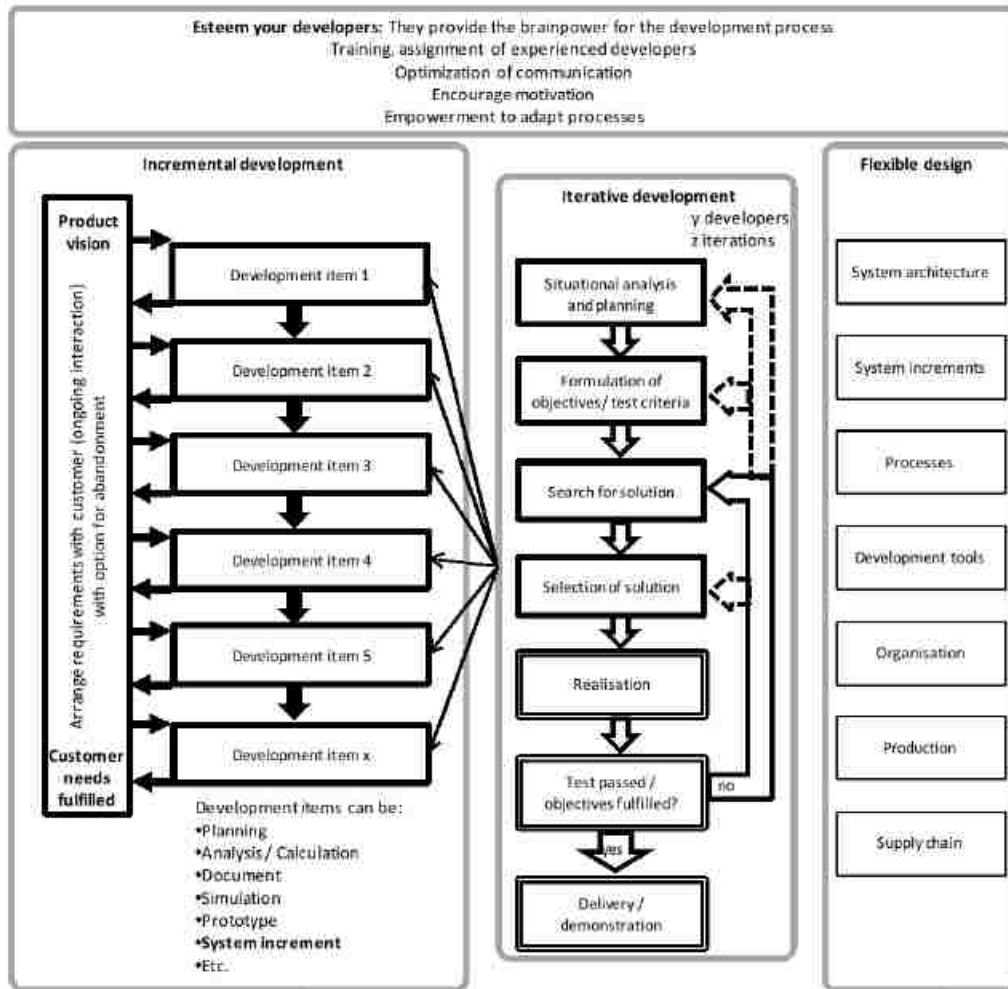

Figure 2.6-1: Stelzmann’s Agile Systems Engineering Action Model

Source: Agility Meets Systems engineering: A Catalogue of Success Factors from Industry Practice (Stelzmann et al., 2010)

ASE focuses more on the developer as opposed to the process, which is a major departure from traditional systems engineering. This is the largest concern that traditional systems engineering practitioners have with ASE. Traditional SE practitioners believe that if you have a strong well documented process, then positive results can be repeatable. Traditional SE practitioners concerns of ASE not adhering to process and lack of documentation are often a misconception. Many engineers

misinterpret the *The Manifesto for Agile Software Development*, as the “advocation of process and tool avoidance, documentation aversion, bending over backwards to please the customer versus contractual commitment issues, and performing in ‘rogue engineering’ mode versus tracking to a schedule. However, a more accurate interpretation is to not allow these things get in the way of productivity, but to *adapt and tailor* the bureaucratic doctrine relative to project-specific needs in order to balance objectives” (Schapiro & Henry, 2012).

Many SE practitioners believe that ASE is only adequate for smaller organizations (Balaji & Murugaiyan, 2012). Individual research by Tudor, Kahkonen, and Schapiro has shown that ASE is possible in large organizations. Tudor’s research showed that it is possible to convert a large organization with traditional practices to agile development practices with success (Tudor & Walter, 2006). Kahkonen’s research provided a methodology for implementing ASE in large organizations through establishing smaller cross-functional teams within a company called communities of practice, which would enable an agile approach (Kahkonen, 2004). Schapiro developed a framework for implementing ASE in large, traditional organizations through making the system architecture modular to enable ASE (Schapiro & Henry, 2012). Although ASE is a more recent systems engineering development, many launch vehicle organizations are beginning to adopt this approach (Gibson, 2019).

2.6.3 Model-Based Systems Engineering

Model-Based Systems Engineering (MBSE) is the application of modeling to support system requirements, design, analysis, verification and validation. MBSE activities begins in the design phase and continues throughout later life-cycle phases. MBSE aims to replace the document-centric approach (INCOSE, 2007; Piaszczyk, 2011; RAmos, Ferreira, & Barcelo, 2012). This model-centric approach’s main artifact is a coherent model representing the desired system being developed instead of just documentation of the system (Bjorkman, Harkani, & Mazzuchi, 2012; Piaszczyk, 2011; RAmos et al.,

2012). The system model coalesces the requirements views of all stakeholders and provides a view of what the system looks like before committing to building hardware, which is unlike any other SE approach. It allows stakeholders to see their vision of the desired system early, compared to other approaches. MBSE drives the validation process towards the beginning of the project. The output of the MBSE design process is a model that contains all the information to build the system, instead of a series of documents. Model-based metrics are used to monitor progress throughout the development. MBSE can be compatible with many of the SE approaches previously described in this literature review. MBSE is considered to be on the leading edge of SE practices. Many organizations are starting to move to a model-based approach due to its benefits.

2.7 Systems Engineering Best Practices and Standard

Many SE best practices are the results of lessons learned during past projects. To get a picture of SE best practices, it is critical to review the documented lessons learned from the development of complex systems over the years. Systems engineering organizations such as INCOSE and NASA compiled extensive lists of SE lessons learned. Both positive and negative lessons learned through the SE process are critical for future projects. Experience gained from past projects can be critical in improving SE capabilities (BKCASE Editorial Board, 2014; Blair et al., 2011; Gill, Garcia, & Vaughan, 2005; INCOSE, 2011). “Applying lessons learned enhances the efficiency of the present with the wisdom of the past” (NASA, 2007). After reviewing lessons learned captured in studies done by Gill, Garcia et al, Blair, Ryan et al, and NASA, the following representation of the themes that were common amongst the literature (Blair et al., 2011; Bruff, 2008; Gill et al., 2005; Kaskowitz, 1990; NASA, 2007; Slegers et al., 2012):

- Establishing the systems engineering infrastructure in the organization is critical
- Requirements should be unambiguous, current, and vetted with all stakeholders

- An effective Systems Engineering Management Plan should be implemented in the earliest possible phase of a project
- Failure to adhere to a sound engineering practice could lead to significant cost and schedule overruns
- The people are the primary resource for successfully developing a system
- Use lessons learned from previous development efforts to promote the success of current and future projects
- Communication is critical to a project's success

Each of the lessons learned found in the literature could be grouped into the following categories:

- Requirements
- Management and Leadership
- System Design/Architecting
- Risk Mitigation
- Verification & Validation
- Technical Analysis

Each one of these common themes among the lessons learned found in the literature that was reviewed could be broken into several elements. For example, "Communication is critical to a project's success" can be broken into elements such as: proper requirements development, communication to and from all stakeholders, team collaboration, and so on.

The lessons learned throughout the modern history of SE led to the development of systems engineering handbooks and standards. The US DoD was one of the pioneers in the development of a

systems engineering handbook in the 1960s. Since then, numerous systems engineering handbooks and standards have been developed. Many of these standards and handbooks reflect systems engineering best practices. Building on some of the work that was done by Honour and BKCASE, Table 1 is a comparison of SE Standards and Handbooks. The handbooks and standards chosen for this comparison were from organizations known for developing complex systems or standards that are commonly used in the industry. The list of standards chosen for this comparison is:

- MIL-STD-499C – Systems Engineering (Pennell & Knight, 2005)
 - The DoD standard for SE mainly developed by the U.S. Air Force
 - The main focus of this military standard is government use and system acquisition
- NASA Systems Engineering Handbook (NASA, 2007)
 - NASA is one of the leading developers of complex systems and has one of the most extensive lists of SE lessons learned
 - Very detailed SE guide tailored for NASA Missions, however is fundamentally applicable to any project, due to the wide range of projects NASA is involved in
- IEEE-1220 – Application and Management of the Systems Engineering Process (ISO, 2007)
 - Intended to be a standard for system development through the SE life cycle
- ISO 90005 – Guidelines for the Application of ISO 9001 to Systems Life Cycle Processes (ISO, 2008)
- EIA-632 – Process for Engineering a System (EIA, 1999)

- Purpose was to provide a fundamental set of integrated processes to assist in the development of a system
- Focuses on requirements of each phase of system development
- ISO/IEC 15288 – Systems and software Engineering System Life Cycle Process (IEEE, 2008)
 - Purpose was to define a set of standards to facilitate communication among system stakeholders
 - Focusses on the system life cycle
- INCOSE Systems Engineering Handbook (INCOSE, 2011)
 - Handbook developed by the words leading organization that promotes the development of SE
 - This handbook is very process focused and educational
- Capability Maturity Model Integration for Development (SEI, 2010)
 - The focus is process improvement, however, identifies SE best practices, and its model is used by many organizations
 - Emphasizes improvement from the use of lessons learned

There were a several other SE standards available, however most were focused on very specific areas of SE or a specific industry. A comparison of the standards listed are found in Table 2.7-1. As you can see, from looking at the comparison of the SE Standards and Handbooks, the same themes present in the lessons learned listed earlier in this section are also present in the standards and handbooks. This gives confirmation that many of the SE lessons learned are reflected in the standards.

Table 2.7-1: Systems Engineering Standards Comparison

		Standards/Handbooks						
		MIL-STD-499C	NASA	IEEE-1220	EIA-632	ISO/IEC 15288	INCOSE	CMMI
Category	Purpose	To describe and require a disciplined systems engineering approach in system acquisition	Provide general guidance and information on systems engineering that will be useful to the NASA community	Provide a standard for managing a system from the concept phase through development, operations, and disposal	Provide an integrated set of fundamental processes to aid a developer in the engineering of a system	Provide a defined set of processes to facilitate communication among system acquirers, suppliers, and other stakeholders in the life cycle of a system	Defines the discipline and practice of systems engineering for students and professionals	Guidance for applying development best practices in an organization
	Requirements	System requirements analysis shall be performed iteratively towards satisfy system requirements	Requirements definition process transforms stakeholder expectations into validated technical requirements <ul style="list-style-type: none"> • Communication and iteration with stakeholders are essential to develop proper requirements • Requirements should describe all inputs, outputs, and relationships between inputs and outputs 	Requirements analysis shall be performed to establish system capabilities and define the following: <ul style="list-style-type: none"> • Stakeholder expectations • Project and organizational constraints • External constraints • Operational scenarios • Measures of effectiveness • System boundaries • Utilization environment • Life cycle process concept • Functional requirements • Design characteristics 	Emphasizes the use or requirements in 5 areas: <ul style="list-style-type: none"> • Acquisition and supply • System Design • Technical Management • Product Realization • Technical Evaluation 	Transform stakeholder view of desired services into technical view of the required product <ul style="list-style-type: none"> • Specify required characteristics, attributes and functional and performance requirements • Identify constraints that will affect system design • Provide requirements traceability • Provide a basis for system verification 	<ul style="list-style-type: none"> • Requirements should be analyzed to transform stakeholder requirements-driven view of desired services into a technical view of a required product • Requirements analysis builds a representation of the future system that will meet stakeholder requirements and has an understanding of any constraints • Requirements should describe and reflect: inputs, outputs, activities, controls, and enablers 	<ul style="list-style-type: none"> • Requirements development identifies customer needs and translates them into product requirements • Requirements are the basis of the system design

		Standards/Handbooks						
		MIL-STD-499C	NASA	IEEE-1220	EIA-632	ISO/IEC 15288	INCOSE	CMMI
Category	System Design/ Architecting	The Systems Engineering Process shall be used to develop the system	The system design is a highly iterative and recursive process that should result in a design solution that validates requirements. The process involves developing: <ul style="list-style-type: none"> • Stakeholder expectations • Technical requirements • Logical decompositions • Design solutions 	<ul style="list-style-type: none"> • A strategy for system development such as Waterfall, Incremental, Evolutionary, or Spiral should be explored • Ability to change or enhance the system should be designed into the system architecture 	Layered development approach to provide the solution to the acquirer and stakeholder requirements	Architecture Design provide a solution that satisfies system requirements <ul style="list-style-type: none"> • Establish baseline architecture design • Describe system elements that satisfy system requirements • Incorporate interface requirements • Provide tractability of architecture design to requirements • Provides a basis for system element verification and integration 	<ul style="list-style-type: none"> • Design should synthesize a solution that satisfies system requirements • Design process is iterative and requires the participation of system engineer as well as relevant experts • System architecture should meet the following criteria: <ul style="list-style-type: none"> - Satisfies requirements - Implements functional architecture - Is acceptably close to the true optimum within time, budget and available resources - Is within technical maturity and acceptable risk limits 	<ul style="list-style-type: none"> • The technical solution to the requirements • Requirements are converted into the product architecture
	System Implementation	Implementation shall be done iteratively in accordance with the systems engineering process to satisfy requirements	Implementation is where plans, designs, analysis, requirements development, and drawings are realized into an actual product <ul style="list-style-type: none"> • Product must satisfy design solution 	Engineering plan should be employed to resolve product deficiencies when system specifications or requirements are not met	<ul style="list-style-type: none"> • Convert requirements into a verified end product in accordance with stakeholder requirements • validate system product and integrate system • Verify the product against requirements 	<ul style="list-style-type: none"> • Transform specified system behavior, interfaces and implementation constraints into fabrication actions • Results in system elements that satisfy design requirements through verification and validation of stakeholder requirements 	<ul style="list-style-type: none"> • Implementation designs, crates, or fabricates a system that conforms to the system's detailed description • Implementation focuses on forming 3 forms of system elements: hardware, software, and humans 	<ul style="list-style-type: none"> • Interface verification is essential in the implementation process • Validation is used to integrate the system in the operational environment

		Standards/Handbooks						
		MIL-STD-499C	NASA	IEEE-1220	EIA-632	ISO/IEC 15288	INCOSE	CMMI
Category	Technical Analysis	Functional and logical analyses shall be performed iteratively throughout the life cycle	Technical assessment is a crosscutting process used to : <ul style="list-style-type: none"> • Monitor technical progress • Provide information to support system design, product realization, and technical management decisions 	Analysis should be used to: <ul style="list-style-type: none"> • Resolve requirements analysis, decomposing requirements, and allocating requirements • Evaluate the effectiveness of alternative design solutions and selecting best design solutions • Assessing system effectiveness • Manage risk 	Technical analysis is used to: <ul style="list-style-type: none"> • provide data for technical decision making • Determine progress in satisfying requirements • Support risk management • Ensure decisions are made after cost, schedule, performance, and risk are evaluated 	Technical Analysis is used to: <ul style="list-style-type: none"> • Define requirements of the system • Transform requirements into an effective product • Use of the system to provide required services • Sustain the required services • Dispose of the product when retired 	Technical process is used to: <ul style="list-style-type: none"> • Define requirements • Transform requirements into an effective product • Permit consistent reproduction of the product • Use the product to provide required services • Sustain the provision of those services • To retire the system 	<ul style="list-style-type: none"> • Alternative solutions are examined to select the optimum design based on established criteria • Emphasizes performing trade studies
	Management and Leadership	The work required to realized the system shall be managed by the developer such as: <ul style="list-style-type: none"> • Requirements development • Integration of the technical effort • Planning and monitoring • Decision making and control • Risk Management • Configuration management • Interface management • Data management • Flow down of requirements and technical management of vendors and subcontractors 	Management is the bridge between the technical team and project management <ul style="list-style-type: none"> • A System Engineering Management Plan needs to be establish prior to the start of the project • Leadership tasks are crosscutting amongst all phases and areas of the project and include: <ul style="list-style-type: none"> - Technical planning - Requirements management - Interface management - Risk management - Configuration management - Data Management - Technical assessment - Decision Analysis 	<ul style="list-style-type: none"> • An engineering plan should be established to guide the project • Plan should control data generated, configuration of the design solutions, interfaces, risks, and technical progress 	<ul style="list-style-type: none"> • Technical management process includes planning, assessing, and controlling of technical work. • A strategy for implementing the management process prior to beginning the project 	Management should define, plan, assess and perform the following: <ul style="list-style-type: none"> • Infrastructure Management • Project Management • Human Resource Management • Quality Management 	Organizational management should direct, enable, control, and support the system life cycle. Management areas include: <ul style="list-style-type: none"> • Life Cycle Model • Infrastructure • Project Portfolio • Human Resources • Quality 	Management tasks include: <ul style="list-style-type: none"> • Integrated Project Management • Project Monitoring and Control • Project Planning • Requirements Management • Quantitative Project Management • Risk Management • Supplier Management

		Standards/Handbooks						
		MIL-STD-499C	NASA	IEEE-1220	EIA-632	ISO/IEC 15288	INCOSE	CMMI
Category	Risk Management	<p>A risk management program shall be established and implemented. Risk shall be assessed in the following areas:</p> <ul style="list-style-type: none"> • Products, process, and their relationships • Contractually identified variations, uncertainties, and evolutions 	<p>Risk management is crosscutting and is a well-organized, systematic decision-making process that proactively identifies, analyzes, plans, tracks, controls, communicates, documents, and manage risks</p>	<ul style="list-style-type: none"> • Risk Management is one of the elements used to control the development of a system • A risk management plan should be established • Risk assessment and handling should be captured by the developing organization 	<p>Risk analysis should be done to develop risk management strategies, support risk management, and decision making</p> <ul style="list-style-type: none"> • Risk management requires discipline • Only useful to the degree that it highlights the need to take action • Risk management is continuous 	<p>Identify, analyze, address, and monitor risks continuously throughout the life cycle of the system</p>	<p>Same as ISO/IEC 15288</p>	<p>Identify problems before they occur to that risk handling activities can be planned and implemented as needed</p> <ul style="list-style-type: none"> • Define a risk strategy • Identify and analyze risks • Implement risk mitigation plan as needed
	Verification & Validation	<ul style="list-style-type: none"> • Verification of requirements shall be repeatedly performed throughout the system development to confirm that documented requirements are met • Validation of the evolving system solution shall be done to provide objective evidence that they system when used as intended meets stakeholder expectations 	<ul style="list-style-type: none"> • The verification process ensures that the systems conforms to the requirements • Validation ensures that the system will do what the customer intended it to do in the intended environment 	<p>Verification is performed to assess completeness of system architecture in satisfying the validated requirements</p> <p>Validation evaluates requirements baseline to:</p> <ul style="list-style-type: none"> • Ensure it represents stakeholder expectations and internal and external constraints • Determine whether all possible system operations and life cycle support concepts have been adequately addressed 	<p>Verification ascertains that:</p> <ul style="list-style-type: none"> • System design is consistent with source requirements • End products at each level of the system are implemented • Ensure product development is appropriately progressing • Enabling products that are required are available when needed <p>Validation demonstrates:</p> <ul style="list-style-type: none"> • products satisfy requirements 	<p>Verification:</p> <ul style="list-style-type: none"> • Confirms that design requirement are fulfilled by the system • Provides information required to effect the corrective actions of non-conformances that occur in the realized system <p>Validation:</p> <ul style="list-style-type: none"> • Provides objective evidence that the system comply with stakeholder requirements and achieve its intended use in the intended operational environment • Confirms that stakeholder requirements are correctly defined 	<p>Same as ISO/IEC 15288</p>	<ul style="list-style-type: none"> • Ensures that product meets specified requirements • Incrementally validates products against customer needs

2.8 Systems Engineering Metrics

The previous section looked at SE best practices and standards. In this section we will look at ways to measure the SE process, namely metrics. Metrics are defined by Merriam-Webster as a standard of measurement. Metrics are used throughout just about every industry to measure different aspects of their business. SE metrics date back to post World War II era, around the time the SE concept emerged (Vanek et al., 2008). Some SE practitioners define SE metrics as measurements that characterizes the quality or performance of a systems engineering process (D. C. Brown, 1998; Gilb, 2008; INCOSE, 2010; Kitterman, 2005; Mahidhar, 2005; Roedler & Jones, 2005; Vanek et al., 2008). Based on the literature reviewed, metrics serve several purposes (Carson & Zlicaric, 2008; Gilb, 2008; INCOSE, 2010; Kitterman, 2005; Mahidhar, 2005; NASA, 2007; Rhodes, Valerdi, & Roedler, 2009; Roedler & Jones, 2005):

- Monitoring the progress and performance of a process or activity
- Adequately communicates throughout the project organization
- Identifies problems
- Can track specific program objectives
- Support decision making

Metrics are a tool to effectively communicate to the leadership of an organization information on the performance of the process or activities being measured (INCOSE, 2010).

Most of the literature reviewed on metrics was consistent in the description of the process used to apply metrics to systems engineering activities. INCOSE, IEEE, Kitterman, Roedler, Mahidhar, and Rhodes described a four-part process. The measurement process identifies four iterative activities: establish, plan, perform, and evaluate the measurements (Carson & Zlicaric, 2008; IEEE, 2008; INCOSE, 2010; ISO/IEC, 2007; Kitterman, 2005; Mahidhar, 2005; Rhodes et al., 2009; Roedler & Jones, 2005).

Their description of each of the four measurement activities may vary slightly, but the underlying activities were the same.

Most literature, describes various types or dimensions of metrics. Roedler and Jones describe metrics types as measures of effectiveness and measures of performance (Roedler & Jones, 2005). Mahidhar describe the metric dimensions that were more general, such as: measure type, tense, and focus (Mahidhar, 2005). In the Systems Engineering Measurement Primer, INCOSE describe two basic types of metrics: measuring technical performance and measuring process (INCOSE, 2010). Rhodes et al's focus was on the tense of the metric (leading or lagging). NASA divides SE metrics into three categories: progress/schedule, quality, and productivity (NASA, 2007).

From the literature that was reviewed, metrics can fall into two categories, leading indicators or lagging indicators. Leading indicators predict what will happen. Lagging indicators or measures characterizes what already happened (Evans & Lindsay, 2014; Mahidhar, 2005). Most literature declare cost, schedule, and technical performance as indications of systems engineering performance (Elm & Goldenson, 2012; Gruhl, 1992; Eric C. Honour, 2004, 2010; Eric C. Honour, Axelband, & Rhodes, 2004; Son & Kim, 2012; Valerdi, 2005). More specifically, cost, schedule, and technical performance describes the return on SE investment, which is a lagging indicator. In the past 10 years, research has been directed more towards leading indicators. There has been research performed by INCOSE, Mahidhar, and Rhodes et al in this area.

Most of the literature generally discuss metrics but few give specifics on what metrics should be used to assess SE. A few pieces of literature give specific examples of useful metrics. Below in Table 2 is a list of performance measures extracted from the literature of INCOSE, NASA, Rhodes et al, Mahidhar, Roedler & Jones, Bruff, Valerdi

- Requirements Trend

- System Definition Change Backlog
- Interface Trends
- Requirements Validation Trends
- Requirements Verification Trends
- Work Product Approval Trends
- Review Action Closure Trends
- Risk Exposure Trends
- Risk Handling Trends
- Technology Maturity Trends
- Technical Maturity Trends
- Systems Engineering Staffing and Skills Trends
- Process Compliance Trends
- Measures of Effectiveness
- Measures of Performance
- Key Performance Parameters
- Technical Performance Measures
- Schedule Performance Index
- Cost Performance Index
- SE Effectiveness
- Program Performance Index
- Scope Performance Index

Most literature agree on the definition of metrics and what they are used for, however, there is a wide range of application tips, guidance, and lessons learned on the use of metrics. Some of the literature give steps on how to implement SE metrics, while others just provide useful tips and lessons learned. The following is a representative of the tips, guidance, and lessons learned on using SE metrics:

- PACTS-21 (D. C. Brown, 1998): Early research by a collaborative research program called PACTS-21, suggested that
 - Great effort should be put into choosing the right metrics
 - Metrics should only be used to compare processes that have similar inputs and outputs
 - Metrics should be used sparingly but should cover all key processes
 - Applying a few simple metrics can be beneficial, however using too many not be beneficial
 - Metrics should be related to an organization's business drivers
 - Data collection of metrics should be automated when possible.
- Technical Measurement Guide (Roedler & Jones, 2005):
 - Organization should factor SE measurements into decision making
 - Metrics must be available early enough to take action and reduce problems or risks
 - The measurement process and risk management should be closely aligned
- A Structured Method for Generating, Evaluating, and Using Metrics (Kitterman, 2005):
 - Use measurements that adequately characterize the desired process
 - Use metrics that will be useful in decision making

- Selected metrics should be well-represented and need relatively little explanation
- Using Performance-Based Earned Value for Measuring Systems Engineering Effectiveness (Carson & Zlicaric, 2008):
 - Metrics must present data that is useful to the organization and motivates action
 - Metrics must support organizational goals
 - Metrics should be well defined, simple, easy to understand, logical and repeatable
 - Data must be easy to collect
- Systems Engineering Measurement Primer (INCOSE, 2010):
 - Limit metrics to those that can lead to better decision making
 - Project risks, concerns, constraints, and objectives should drive the measures and indicators selected
 - The core set of metrics should be kept small and limited to approximately 6
 - Assign an owner to the measurement process
 - Re-evaluate the metric program regularly
 - Have a defined measurement process before metrics are taken
 - Try to find a way to use metrics in a way such that the team views the use of the metrics positively
 - Utilize metrics that use data that is naturally available
 - Data collection for metrics should be automated as much as possible

As you can see from the lessons learned and guidance listed above, there are four themes that were consistent among the literature: (1) the metric selection process is very important and a lot of thought and consideration should be put into choosing the right metrics, (2) a small number of metrics covering key processes should be used, (3) data collection should be automated when possible, and (4) metrics should support organizational objectives.

2.9 Implementing Systems Engineering

Numerous researchers agree that implementing a systems engineering process in an organization would help to increase the chances of project success (Dean, Bentz, & Bahill, 1997; Eric C. Honour, 2010; Eric C. Honour et al., 2004; NASA, 2007). Researchers also suggest that to implement SE in an organization, there needs to be an awareness and understanding of SE (Czaja, Dumitrescu, & Anacker, 2016; EIA, 1999). Most literature found is very consistent on the purpose of implementing systems engineering, however, there was a large dispersion on the level of detail provided on implementing systems engineering in an organization. There was very few pieces of literature found that provided great detail on how to implement systems engineering, this is likely due to that fact that the systems engineering processes are individually tailored by organizations for their specific application and needs.

2.9.1 Planning, Controlling, and Assessment

Most SE standards suggests that implementation of a SE process in an organization, requires some form of planning, control, and assessment of the SE process (EIA, 1999; INCOSE, 2011; ISO, 2007; NASA, 2007; SEBoK authors, 2016). EIA (1999) and NASA (2007) identifies the process of planning, controlling, and assessing systems engineering as technical management. Whereas, INCOSE (2007) describes this process as Project Planning and Controls. Although standards may use different names, all agree that planning, control, and assessment of the SE process is essential.

2.9.1.1 Planning

Planning the systems engineering process is considered by leading SE organizations, such as INCOSE, NASA, IEEE, and SEBoK to be one of the most important aspect of implementing a systems engineering process. According to leading SE organizations, the purpose of planning the systems engineering process is to effectively communicate a workable guide for the systems engineering process (EIA, 1999; IEEE, 2008; INCOSE, 2011). As previously identified as a SE best practice in Section 2.7, planning of the systems engineering process should occur as early as possible. This sentiment was echoed in much of the literature that was reviewed. SEBoK authors (2016) warned that inadequate complete and rushed SE planning could cause significant impacts to project cost and schedule.

The literature from leading SE researchers were very consistent in in stating that planning of the SE process should be documented prior to implementing systems engineering (INCOSE, 2011; NASA, 2007; SEBoK authors, 2016). However, the literature varies on the name of the documented plan. Some researchers refer to the plan as the Systems Engineering Management Plan (SEMP), Systems Engineering Plan (SEP), Engineering Plan, or Technical Management Plan. For the purposes of this research, the documented plan of the systems engineering process will be referred to as the SEMP. Most major SE organizations agree that the major elements of the SEMP should:

- Describe the system being developed
- Describe the technical management of the project
- Identify tailoring of the SE process and the life-cycle approach to be used
- Describe integration of the technical disciplines into the SE process

2.9.1.2 Control and Assessment

Organizations such as EIA (1999), NASA (2007), IEEE (2008), and SEBoK authors (2016) identify assessment and control as another important aspect of implementing SE. The purpose of

assessment and control is to determine the performance of the SE process on meeting cost, schedule, and technical requirements. Most literature agree that this is accomplished through the various technical and SE life-cycle reviews, such as systems requirements reviews, preliminary design reviews, critical design review, and design certification reviews. Details of assessing the SE process is described in Section 2.11.

2.10 Enabling Systems Engineering

Any organization that seeks to employ systems engineering has to make appropriate preparations to effectively implement a systems engineering process (SEBoK authors, 2016). Three factors for enabling SE in an organization were identified in the literature reviewed: culture, SE competencies, and SE tools and infrastructure (INCOSE, 2011; Oppenheim et al., 2011; SEBoK authors, 2016). The themes of these three factors for enabling SE were also present in the SE best practices identified in Section 2.7. This shows that there is consistency between enabling SE and best practices for SE. The SE Tools and infrastructure which was identified as an enabler refers to the different systems engineering models, which were discussed extensively in Section 2.5 and 2.6.

2.10.1 Systems Engineering Culture

Organizational culture has been the topic of many studies to understand the psychology behind the behaviors of an organization (Schein, 1990). All though there has been some differences on the exact definition of organizational culture, most researchers agree that organizational culture can be described as the common beliefs, values and behaviors shared throughout the organization (Alsowayigh, 2014; Hogan & Coote, 2014; Iivari & Huisman, 2007; Schein, 2004). These organizational beliefs are buried behind various layers within the organization and has a strong influence on the behaviors of people within the organization. It is important to study the beliefs and perceptions of the people in the organization to understand organizational culture (Alsowayigh, 2014; Hogan & Coote, 2014; Schein, 2004).

The culture of an organization forms the background in which the systems engineering process is executed (Iivari & Huisman, 2007). Culture, as it applies to SE is described by numerous SE researches, as the values, beliefs, and normal practices of an organization (Carroll, 2016; Iivari & Huisman, 2007; NASA, 2003; SEBoK authors, 2016). Carroll and SEBoK authors describe culture as a critical aspect of implementing SE. Oppenheim et al. (2011) had a very succinct definition of SE culture. Oppenheim described SE culture as “a pervasive mental state and bias for systems engineering methods applied to problem solving across the development lifecycle and all levels of enterprise processes” (Oppenheim et al., 2011). Researchers believe that a culture that promotes effective SE, encourages systems thinking. SE organizational culture is believed by some researches to be an aggregate of leadership, the industry of the organization, and relationship with competitors (SEBoK authors, 2016). A healthy SE culture is described by the SEBoK authors as being strong in the following elements:

- Leadership
- Trust and morale
- Cooperation and teamwork
- Empowering employees
- Confidence in the processes and practices
- Job security

SEBoK authors warn of two SE cultural shortfalls to avoid. The first is referred to as “Risk Denial”. Risk Denial is described as a cultural reluctance to recognize the true risk associated with the system. An example of risk denial is considered by SEBoK to be the Space Shuttles Challenger and Columbia accidents, where there was a cultural reluctance to recognize the risk of launch. The second cultural shortfall mentioned by SEBoK authors is referred to as the “Titanic Effect”. This is described as the belief that a system is safe when in fact, the system is not. The example of this is the Titanic ocean liner catastrophe.

There have been very few studies completed that focuses on systems engineering within the organizational culture. However, numerous organizational culture studies have been completed that focuses on an area closely related to systems engineering. In recent years, organizations in high risk industries, such as the launch vehicle industry, have focused on effect on organizational culture on safe operations (Gibbons, von Thaden, & Wiegmann, 2006). Launch vehicle mishap investigations such as the Challenger and Columbia space shuttle accidents were partially attributed to safety culture (NASA, 2003).

Safety culture has been the focus of numerous organizational culture studies. Much like systems engineering, safety has to be considered and evaluated all throughout the development life-cycle and requires a holistic view. A large part of safety is risk management, and risk management is a very large part of systems engineering. As you can see there is a lot of overlap between safety and systems engineering, which is why a lot of the principles of evaluating safety culture within organizations can be applicable to studying systems engineering culture. Researches such as Schein (2004), Taylor (2010), and Patankar, Brown, Sabin, and Bigda-Peyton (2012) believe that there are layers to the safety climate of an organization. Patankar and Sabin developed layered safety culture pyramid illustrated in Figure 2.10-1.



Figure 2.10-1: Safety Culture Pyramid

The safety culture pyramid model consist of four layers. Behaviors are at the top of the pyramid. In this model, behaviors are translated to performance. The next layer of the pyramid are attitudes and opinions, which influences performance. The third layer of the pyramid are organizational mission, leadership, history, norms, heroes and legends. The bottom layer of the pyramid are underlying values and unquestioned assumptions (Patankar et al., 2012). Patankar described the pyramid model as a multi-dimensional reflection of the dynamic nature of safety culture. The elements of the pyramid are common to all organizational cultures. Given the commonality of these culture elements amongst organizations, the dynamic and multi-dimensional nature of systems engineering, and the overlap of systems engineering and safety, this safety culture pyramid model can be applied to systems engineering.

2.10.2 Systems Engineering Competencies

Systems engineering competency is described by Whitcomb, Khan, and White (2014) as the measure of the ability of a SE to appropriately apply knowledge, skills, attitude, and abilities in order to successfully execute the systems engineering job. Understanding SE competencies is critical for enabling SE in an organization. It helps the organization to understand what training, education, and experience is needed to allow its personnel to successfully implement systems engineering (SEBoK authors, 2016; Whitcomb et al., 2014). Many large systems engineering organizations such as Department of Defense, INCOSE, NASA, and CMMI, develop competency models that identify a list of competencies needed to practice good systems engineering. Many of the systems engineering standards identified in Section 2.7 discuss systems engineering competencies.

2.11 Assessing Systems Engineering

After review literature on SE metrics, literature was reviewed on how to assess systems engineering. To assess systems engineering, one must understand what it takes to make systems engineering successful. BKCASE Editorial Board (2014) determined that the purpose of assessing

systems engineering is to maintain sufficient insight into the project's technical progress and risks. Many believe that the way to assess systems engineering is to evaluate cost, schedule, and technical performance of the system that was developed. This principle is what led Valerdi to develop the Constructive Systems Engineering Cost Model (COSYSMO). However, COSYSMO was based on little systems engineering data from only successful programs and varying perceptions and definition of systems engineering (Bruff, 2008; Eric C Honour & Valerdi, 2006; Valerdi, 2005).

Valerdi was not the only researcher to assess systems engineering by cost and schedule. Elm & Goldenson; Gruhl, Honour et al, Son & Kim, and Componation et al made cost and schedule the focus of assessing systems engineering. Research completed by Componation et al, using data from NASA projects, sought to link project success with the systems engineering process. Componation's research found a correlation, but the correlations were between cost and schedule, and not project technical success (Componation, Utley, Farrington, & Youngblood, 2009). Robert Bruff at Walden University sought to link SE best practices with cost and schedule savings. Bruff's researched showed that SE best practices had a strong correlation to cost, schedule, and overall program performance (Bruff, 2008). Cost and schedule was the focus of the majority of the literature associated with assessing systems engineering. Very little literature focused on specifically the technical performance.

ISO (2007), IEEE (2008) and INCOSE (2011) published literature on the project assessment and control process as methods of assessing the project. The objectives of the project assessment and control process is to evaluate the performance of the projects plans with respect to cost, schedule, and technical objectives. Assessments are to be performed at various points throughout the project life-cycle. These assessments should come in the form of technical reviews at all project milestones. ISO (2007), IEEE (2008) and INCOSE (2011) suggested that a successful project assessment and control review would result in the following:

- Adequate assessment of project performance including performance measures

- Assessment on if the roles, responsibilities, authorities, and resources allocated to the project are sufficient to achieve project success
- Identification and evaluation of risks associated with the project
- Informing all project stakeholders of project status

These elements would allow decision makers to make informed decisions and direct project efforts as necessary. ISO, IEE, and INCOSE's literature provided a great overview of the project assessment and control. Their literature was focused mainly on the project performance, and not the performance of the systems engineering process itself. The NASA Systems Engineering Handbook and Systems Engineering Body of Knowledge built upon the work that was done by ISO, IEE, and INCOSE and expanded the assessment and control elements to include elements to improve the systems engineering process itself, and not just the particular project. The NASA (2007) and BKCASE Editorial Board (2014) included elements such as:

- Evaluation of project against the organization's SEMP
- Hold a review after the completed system is delivered to capture lessons learned to improve process moving forward

2.11.1 Best Practices for Project Assessment and Control

Similar to other SE best practices, best practices are the results of lessons learned during past projects. Experience gained from past projects can be critical in improving SE capabilities (BKCASE Editorial Board, 2014; Blair et al., 2011; Gill et al., 2005; INCOSE, 2011). Systems engineering organizations such as INCOSE, NASA, and SEBoK have compiled lists of best practices for project assessment and control. A consolidation of the key best practices for project assessment and access control are (BKCASE Editorial Board, 2014; INCOSE, 2011; NASA, 2007):

- Maintain an independent evaluation and recommendations on schedule, technical condition, resources, and risk guided by experience and trend analyses
- Ensure technical reviews are decision gates that must be passed for work to proceed
- Perform peer reviews of technical review products
- Make the action items and action item status visible to all stakeholders
- Hold reviews after the system has been delivered to document lessons learned
- Utilize project monitoring, configuration management, and risk management to identify critical areas
- Only collect measurements used in decision-making

Similar to the elements of project assessment, the best practices focus primarily on evaluating project performance of the project and not evaluating the actual systems engineering process itself.

2.12 Critical Success Factors

2.12.1 Project Management and System Engineering

There is a symbiotic relationship between project management and systems engineering. There is much overlap between the two (BKCASE Editorial Board, 2014; INCOSE, 2011; NASA, 2007).

However, the overlap can vary based on the organization and project. In some organizations, project managers and systems engineers have very little overlap and/or communications, whereas in others, both jobs are done by the same person (BKCASE Editorial Board, 2014). Project management is responsible for the overall project, which includes planning, implementing, controlling, budget, schedule and status reporting (Fleming & Koppelman, 2005; Nicholas & Steyn, 2012). Whereas systems engineering is focused on the technical aspects of the project (BKCASE Editorial Board, 2014; INCOSE, 2011; SEBoK authors, 2016).

Project management has been heavily targeted for critical success factors (CSFs) studies for decades, leading to an abundance of literature on the subject. However, very little literature exists specifically studying the critical success factors of systems engineering. Since there is much overlap between project management and systems engineering, literature of the CSFs of project management was reviewed to gain insight into the critical success factors of systems engineering. Since this literature review is focused on Systems Engineering, literature review on CSFs of project management was not exhaustive, however sufficient literature was reviewed to gain an understanding of the CSFs of project management.

2.12.2 Critical Success Factors of Project Management

Belassi and Tukel (1996), considered pioneers on the critical success factors of project management suggested that vigorous research on the critical success factors of project management would need to distinguish between project success criteria and project success factors. Project success criteria are those elements by which the success of the project is measured, such as cost schedule, required quality, and customer satisfaction (Belassi & Tukel, 1996; Fortune & White, 2006; Müller, Söderland, & Jugdev, 2012; Randt, Waveren, & Chan, 2014; Shenhar, Tishler, Dvir, Lipovetsky, & Lechler, 2002; Slevin, 1987; Westerveld, 2003). Although many researchers agree that cost, schedule, required quality and customer satisfaction are project success criteria, there is little agreement that these are the only four dimensions of project success criteria. Some researchers argue that there are other dimensions to the success criteria, since success means different things to different people, but there is very little consensus on the other dimensions of project success criteria.

Projects success factors are considered by many to be the elements that when influenced increases the likely food of success of the project. Project success factors can be organization, environmental, and/or external to the project itself. (Belassi & Tukel, 1996; Fortune & White, 2006; Müller et al., 2012;

Randt et al., 2014; Shenhar et al., 2002; Slevin, 1987; Westerveld, 2003) Numerous researchers have compiled extensive list of critical factors, many of the list varied in the number of factors identified.

Table 2.12-1: Fortune and White's Compiled List of Project Critical Success Factors

<u>Rank by appearance</u>	<u>Project Critical Success Factors</u>
1	Support from senior management
2	Clear realistic objectives
3	Strong/detailed plan kept up to date
4	Good communication/feedback
5	User/client involvement
6	Skilled/suitably qualified/sufficient staff/team
7	Effective change management
8	Competent project manager
9	Strong business case/sound basis for project
10	Sufficient/well allocated resources
11	Good leadership
12	Proven/familiar technology
13	Realistic schedule
14	Risks addressed/assessed/managed
15	Project sponsor/champion
16	Effective monitoring/control
17	Adequate budget
18	Organizational adaptation/culture/structure
19	Good performance by suppliers/contractors/consultants
20	Planned close down/review/acceptance of possible failure
21	Training provision
22	Political stability
23	Correct choice/past experience of project management methodology/tool
24	Environmental influences
25	Past experience (learning from)
26	Project size (large)/level of complexity (high)/number of people involved (too many)/duration (over 3 years)
27	Different viewpoints (appreciating)

Fortune and White (2006) performed an exhaustive literature review of the critical success factors of project management and compiled a list of factors in order by frequency of appearance in literature. Not all literature reviewed identify all 27 factors listed in Table 2.12-1, however most of the literature agrees on the top three factors. Project management CSF literature published after Fortune and White compiled the CSF list was reviewed, and the recent literature remained consistent with Fortune and White's list.

2.13 Systems Engineering and Launch Vehicle Failures

There have been numerous pieces of literature discussing launch vehicle failures, however very few specifically examining how systems engineering impact launch vehicle failures. Most failure analyses performed on launch vehicle failures seek to identify root cause of the failure, but usually does not look specifically to identify system engineering deficiencies. In 2001, J. Steven Newman conducted a study at NASA taking a systems engineering look at 50 space systems failures. Newman found that all 50 failures could be attributed to deficiencies in some area of systems engineering (Newman, 2001). The results of Newman's findings are summarized in Table 1.3-1. Gill et al. (2005) conducted a lessons learned and systems engineering application using space systems failures and agreed with many of Newman's findings. Other published research on launch vehicle failures have been completed by Chang (1996), Isakowitz, Hopkins, and Jr. (2004), Harland and Lorenz (2005), and Leung (2014) may not specifically link the causes to systems engineering, but all failure causes identified were related to one or more of the areas of systems engineering identified in Newman's research.

Table 2.13-1: A Systems Engineering Look at 50 Space Systems Failures Summary

<u>Systems Engineering Element</u>	<u>Contributing Cause</u>	<u>Proximate Cause</u>	<u>Total</u>	<u>Percentage of Total Causes</u>
Requirements Development	0	0	0	0%
Program Management	3	3	6	4%
Systems Engineering Management	15	0	15	11%
Design	10	21	31	22%
Design Test & Verify	8	8	16	12%
Software Design	1	2	3	2%
Software Test & Verification	4	4	8	6%
Production/Manufacturing	5	20	25	18%
Prod/Mfg Test and Verification	25	1	26	19%
Operational Planning	4	0	4	3%
Pre-Op Test & Verification	0	0	0	0%
Policy/Cost/Schedule	3	2	5	4%
Total	78	61	139	100%

NOTE: A space system failure can multiple causes

2.14 Gaps in Literature and Obstacles

There are a number of SE standard and handbooks available in the SE community to give guidance to SE practitioners. Each of the standards reflects years of SE experience and documented lessons learned. Each standard gives a good description of what SE requires and provide overviews of

each step in the systems engineering process. When it comes to SE implementation, the standards and handbooks are very general and only provide what the purpose or goal of SE implantation. Very little treatment was given to SE implantation compared to the other elements of SE. None of the SE standards, handbooks, or other literature reviewed provided information on the key factors of SE implementation. This is one of the major gaps noted during the literature review. Understanding the detailed elements of implementing systems engineering would be helpful to many organizations trying to implement a systems engineering process, particularly since breakdowns in the SE process could be catastrophic for an organization.

An obstacle identified with understanding SE implementation is that there are a wide variety of ways SE can be implemented in an organization. Systems Engineering solutions are tailored to a particular industry or organization (BKCASE Editorial Board, 2014). This would present challenges in understanding key elements of SE implementation. In addition, there is a variety of system engineering models that would play a factor in addition to the customization of the SE process to a particular industry.

Many SE documents focus primarily on evaluating how well the project is performing, but very little focus on evaluating an organization's systems engineering processes itself. None of the standards provide any guidance on how to assess the systems engineering practices of an organization. This is a literary gap in SE literature that could prove useful. Many organizations contract out the development of a complex system, and as part of selecting a viable contractor, understanding the quality of SE of a potential contractor is critical. Guidance in international SE standards and handbooks on how to evaluate the systems engineering practices and abilities of a potential contractor could prove useful.

In addition to very little literature being found on how to assess systems engineering practices of an organization, there was no literature found on whether or not an organizations systems engineering practices can be effective without having a dedicated systems engineer. Many pieces of literature spoke about the value of systems engineering, but no literature could be found that discussed how the SE

process requires a person within the organization whose major purpose is to facilitate systems engineering. Some organizations state that systems engineering can be done collectively as a group of discipline focused engineers and there is no need for a dedicated systems engineer or dedicated systems engineering group within the organization. However, there was insufficient literature found to support or refute that claim.

Another gap that was identified in the literature was in how SE metrics relate to the different SE models. There is a lot of literature on how to develop and implement metrics and what metrics are useful. However, there is very little literature that shows how SE metrics relate to or should be used in specific SE models. For Example, *The Technical Measurement Guide* (Roedler & Jones, 2005) discusses which phase of the Vee Model certain types of metrics should be taken, but only the Vee Model was discuss. With the emergence of non-traditional SE models guidance on how the various SE metrics relate to the various traditional and non-traditional SE models would be valuable. There may be certain metrics that are more suitable for a particular type of SE model, understanding the relationships could be useful.

There are two obstacles with the use of SE metrics found in the literature. The first obstacle is that people do not like to be measured (INCOSE, 2010). This may cause the team or employees to resist or put little effort into utilizing SE metrics. The second obstacle is “gaming”. Systems engineering organizations may play games or manipulate variables to make the SE metrics present their organization in a more favorable manor than it should (Eric C. Honour et al., 2004).

When it comes to evaluating the systems engineering practices of an organization, much of the focus in the literature is on SE effectiveness, namely if the project was successful in meeting cost and schedule. Most of the literature focus on cost and schedule but very little on the technical performance. More research in this area is needed. Evaluating the SE practices of an organization could prove valuable. Cost and schedule are major contributors for system developer selection, however, for some organization, technical performance is just as or even more important than cost and schedule. The few

pieces of literature that look at technical performance focus on the system itself rather than the organizations SE practices. In addition, another gap was found in assessing the risk of an organization's SE practices. There was literature available of assessing project risk at various stages of the life cycle, but nothing specifically on the assessing risk of an organization's SE practices.

There was one primary gap identified when literature was reviewed that linked systems engineering deficiencies with launch vehicle failures. The bulk of the systems engineering approach to assessing launch vehicle failures was completed in 2001, which was 16 years ago. Since that time, there has been numerous developments in the launch vehicle industry. Many of the launch vehicles that were flying during that time period, and new launch vehicles, as well as new launch vehicle providers have entered the market since that time. There has also been many developments in system engineering and systems engineering approaches since 2001. The literature reviewed does not account for recent developments in the launch vehicle industry as well as recent developments in systems engineering approaches.

There has been an abundance of studies examining the CSFs of project management, but very few looked at systems engineering specifically. Even though there is overlap between systems engineering and project management, they are still two distinct disciplines. Project management is focused on the overall project and focuses mainly on cost and schedule, whereas systems engineering focuses mostly on the technical aspects of a project. Therefore, the lack of CSF studies specifically on SE is considered a literary gap.

2.15 Literature Review Conclusion

Organizations such as INCOSE, IEEE, DoD, and NASA are and continue to be world leaders in systems engineering. The SE practices used across many industries stem from the work of these

organizations. Lessons learned compiled over decades of complex system development have evolved into SE best practices, and the best practices are reflected in standards and handbooks. Use of these best practices has shown to have a positive effect on cost, schedule, and project performance.

When it comes to assessing SE practices of an organization much of the focus is on cost and schedule. There are many methods available for assessing the effectiveness of SE to deliver a system within cost and schedule. However, a method of specifically assessing the technical performance or the SE practices of an organization would have to be developed. More specifically, methods found for assessing systems engineering focus on the project cost and schedule performance, and not the systems engineering process itself. The ability to assess the critical factors associated with the implementation of SE within an organization would prove useful to any organization that needs to understand the critical factors for implementing systems engineering. The use of metrics is a potential tool for assessing SE practices, however, much research would need to be done to understand the best SE metrics to use and how to use them. Research would also have to be completed on which metrics or what type of metrics are more effective for the different SE models. This would be useful in developing a method for assessing SE. When examining how systems engineering applies to launch vehicle failures, the bulk of the research in this area is over 16 years old and should be updated.

Hsu, Raghunathan, and Curran, summarized very well the state of systems engineering in today's society that is very applicable to why the critical factors of implementing systems engineering is needed: "Modern society is characterized by complex networks and systems: e.g. transport systems, health and local government services, defense systems, communication systems, etc. Systems engineering is a structured approach to the management of such complex problems; it provides a framework for the integration of people, processes, tools, information, and technology. Thus, Systems Engineering is a core competence required by industry, government, and service providers, and the training of high quality Systems Engineers is a matter of competitive necessity" (Hsu, Raghunathan, & Curran, 2008). These are

the reasons why understanding the critical factors in implementing the systems engineering in a launch vehicle organization is invaluable.

CHAPTER III: METHODS AND PROCEDURES

3.1 Introduction

The severity of the impact of launch vehicle failures has led to the emphasis on strong systems engineering in efforts to improve launch vehicle reliability. For organizations seeking to entrust human lives, national security critical, or extremely expensive payloads to launch vehicles, it's important to understand the factors effecting the systems engineering of the organizations developing and launching the launch vehicles. Therefore, the focus of this research is to determine the significant factors that influence systems engineering in a launch vehicle organization by answering the following questions:

- What influence does systems engineering culture have on launch vehicle problems?
- What is the effect of systems engineering support on launch vehicle problems?
- What effect does top management support have on systems engineering culture?
- What effect does experience have on systems engineering culture?
- What influence does systems engineering culture have on systems engineering rigor?
- What is the effect of systems engineering support on launch vehicle problems?

3.2 High-Level Research Method

The high-level research method described in this section identifies the overall processes used to carry out this research. It identifies the key elements used to identify the problem, develop the hypothesis, and test the hypothesis. Figure 3.2-1 below shows a diagram of the process. This provides a high-level roadmap for the research.

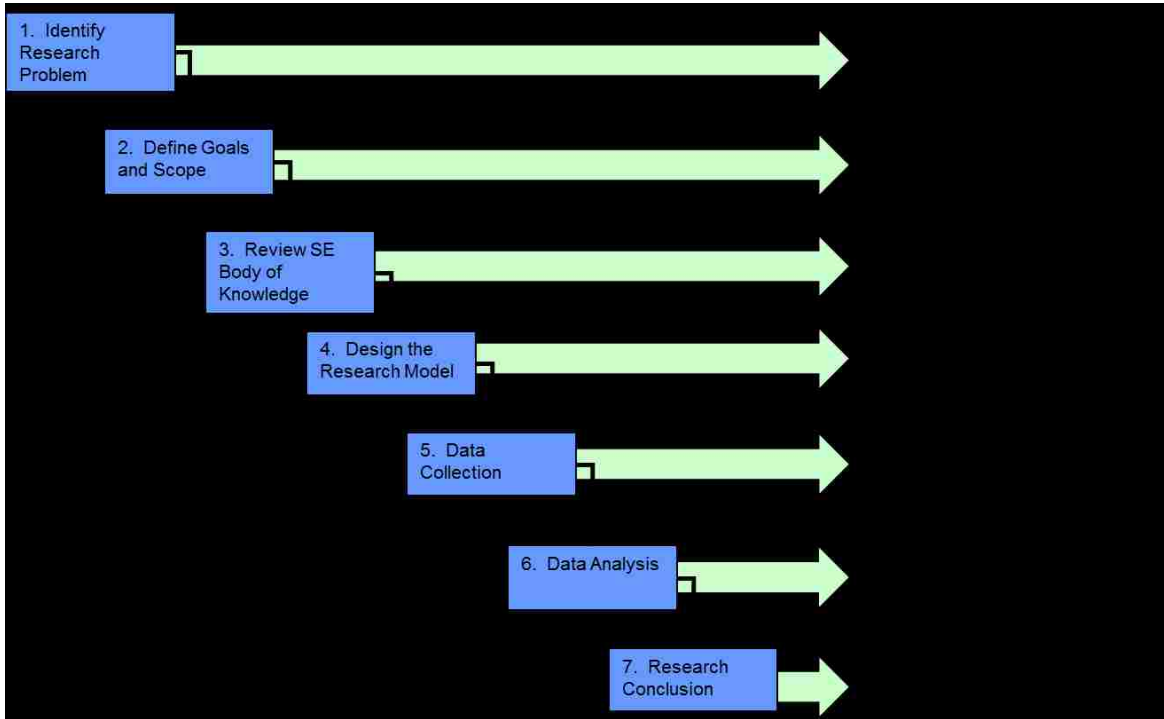

Figure 3.2-1: High-Level Research Methodology

In the high-level research method, the first step is to identify the research problem. This is the beginning phase of the study, which is detailed in Chapter I Section 1.1. The need of this study was identified through a combination of literature review, first-hand observation by the researcher, and the need being directly communicated by government organizations. There is great interest by the space community to understand the factors influencing systems engineering in launch vehicle organizations.

The second step, is defining the goal and scope of the research. The hypothesis of the research as well as the research questions and sub-questions are identified in Chapter I Section 1.2. The research objective can be found in Chapter I Section 1.3. The hypothesis, research questions, and objectives provide the goal and outline the scope of the research. This step also helps to determine the boundaries and limits of the research. The research limitations can be found in Chapter I Section 1.4,

Performing a literature review is the third step of this research process. This phase provides a look at literature and research related to the research topic. The literature review is critical in identifying gaps in research. The research gaps found in the literature aid in formulating the research process and can be found in Chapter II.

The fourth step of the high-level research methodology is data collection. This research will follow a qualitative research design. The more detailed model of the research approach will be described in later sections of this chapter. The fifth step is to collect data from relevant industry sources. Step six is to perform an analysis on the data collected in step five. The final step, step seven, is to develop a conclusion based on the analysis of the data collected in previous steps. In step seven the research is summarized, and findings and recommendations identified.

3.3 Research Design

Developing a complex system can be a complicated process. Identifying the factors that effects SE in a launch vehicle organization can be equally or even more complicated. There are many factors that systems engineering researchers have to account for. The complexity of systems engineering and its processes makes it difficult to perform quantitative research. It is difficult to isolate variables and perform standard treatments of variables. Since organizations typically customize their SE process unique to their company, many of the systems that are being developed are unique systems or only have been developed once. This makes it difficult to identify a control case, replicate, and generalize results (Valerdi & Davidz, 2009).

There are many individuals that are involved in implementing the systems engineering process, and each has a different role and perspective of the process. A qualitative research approach is very similar to systems engineering. Many researchers believe that qualitative research focuses on phenomena and all of its complexities. In qualitative research, there are multiple perspectives by the individuals

participating in the phenomena, with each having an equally valid perspective. Qualitative research involves combining questions and procedures, data collected in the natural setting, inductively building data from themes, and interpreting the data (Creswell, 2014). This study follows a qualitative research approach.

Research completed by Niazi, Wilson, and Zowghi suggests that most “Critical Success Factors” research has been conducted via surveys (Fortune & White, 2006; Niazi, Wilson, & Zowghi, 2005). Numerous researchers such as Segura Morales (2014), Chou and Ngo (2014), Gambi, Boer, Gerolamo, Jørgensen, and Carpinetti (2015), has conducted research using surveys as the primary data collection to in systems engineering related fields that examined various aspects of the organization using structural equation modeling. Their approach and areas of inquiry are very similar to what was examined in this study, which is why a survey was used in this study. Surveys are widely used throughout various areas of research to collect data. Surveys provide a mechanism to acquire information from large groups of people—about their characteristics, experiences, practices, or opinions—through asking questions and compiling the data systematically (Leedy & Ormrod, 2013). Surveys are one of the more efficient and practical ways of collecting data from a group of people. The research design is illustrated in Figure 3.3-1.

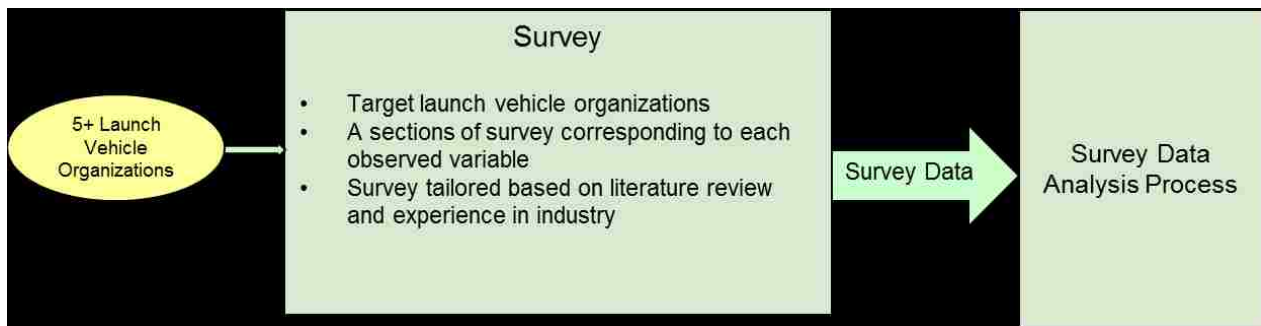

Figure 3.3-1: Research Design

3.4 Research Model

In this section, the proposed research model is identified. The research concept and model was developed following the high-level research methodology. The research conceptualization was the process used to develop the constructs of this study; constructs are the ideas or notions that were investigated in this study. Conceptualization is the process where meaning is given to the constructs or concepts of the study. During this process, abstract definitions and theories are applied to each construct (Mueller, 2004). The constructs developed in this study are formed based on the research questions and literature review. It's important to establish preliminary construct definitions, they will provide the researcher a starting point for the inquiry of a research investigation (Yin, 2009). The constructs are refined after survey data is analyzed. During this research study, these constructs are characterized and measured. The research model is an illustration that shows the relationship between the constructs of this study and the research hypotheses. The proposed research model evaluating the relationships between systems engineering culture, systems engineering support, systems engineering rigor and launch vehicle problems was formed. An illustration of the proposed research model can be found in Figure 3.4-1 below.

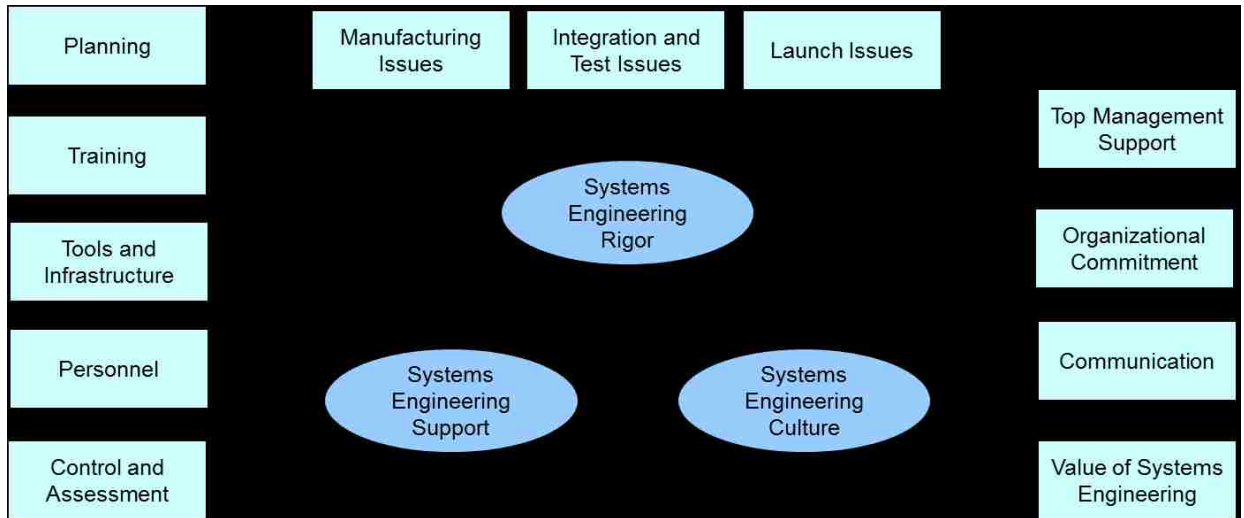

Figure 3.4-1: Research Model

3.5 Survey Approach

Surveys are frequently used in research to provide numeric data about trends, opinions, or other information about a population by examining a subset of that population (Creswell, 2014; Leedy & Ormrod, 2013). The survey was administered to a group of systems engineering managers and practitioners in launch vehicle organizations. The survey is constructed such that each survey question is relevant to a research hypothesis or question. From examining the various research tools, surveys are the ideal tool for reaching a broad population of people. In conducting survey research, it's better to have too large of a sample population than to have a sample population that is too small (Kitchenham & Pfleeger, 2003). The survey provides quantitative data that is used to statistically test the research hypothesis.

3.5.1 Research Variables

The research variables in this study are the factors measuring systems engineering culture, system engineering support, and systems engineering rigor, top management support, and experience. Systems engineering culture, systems engineering support, and systems engineering rigor are all considered to be latent variables. Systems engineering culture is the endogenous variable affecting systems engineering support and systems engineering rigor. Systems engineering rigor was also the mediating variable between systems engineering support and launch vehicle problems. Demographic information such as experience also factored in to the analysis. Each variable is described in detail in the following sections.

3.5.1.1 Top Management Support

To effectively conduct this research, it was important to understand the leadership's approach to implementing systems engineering. For the objectives of this research, "Top Management Support" construct represents the aspects of organizational senior management that are critical for implementing systems engineering. Organizational culture and leadership research completed by Schein (2004), Hogan and Coote (2014), and Chatman and O'Reilly (2016) showed that the leaders of the organization starts, embeds, and transmits their values, beliefs, and assumptions on the organization. Particularly senior leadership of the organization that responsible for setting direction, strategy, and goals of the organization. Development Dimensions International, an international executive development program performed research on the roles of senior leadership of organizations and found that effective senior leadership (Appelbaum & Paese, 2002; Hout & Carter, 1995):

- Develops long term strategy for the organization
- Remove obstacles
- Use authority to resolve complex key issues
- Actively align capabilities, resources, and stakeholders

- Cultivate passion and commitment toward a common goal
- Manage political conflicts

Based on Appelbaum's and Hout's research on the role of organizational leadership, it's easy to see why evaluating top management support is important to gain insight in to systems engineering implementation in a launch vehicle organization. For this study, Top Management Support will include all engineering management and program management, up to and including the chief executive officer.

Project critical success factors study show that the top critical factor for project success is senior management support (Belassi & Tukel, 1996; Fortune & White, 2006; Müller et al., 2012; Randt et al., 2014; Shenhar et al., 2002; Slevin, 1987; Westerveld, 2003). Particularly in the launch vehicle industry, management support is critical. Often, the systems engineering process will be producing a launch vehicle that costs anywhere from tens of millions of dollars to hundreds of millions of dollars. In addition, these launch vehicles may be carrying people or payloads that can be worth billions of dollars. Therefore, it's important to the systems engineering process to have management support to use their authority to resolve key issue, remove obstacles, manage political conflicts, and cultivate commitment towards a common SE goal. Based on the literature review, Top Management Support is important to systems engineering implementation. There are five items in the survey instrument that participants are asked to respond to that measures the survey participants' perception of top management's support of systems engineering.

3.5.1.2 Organizational Commitment

Organizational commitment is an indicator that measures how much the systems engineer is committed to the organization. This provides an indicator of how loyal the systems engineer is to the organization, and how well they are willing to put in the extra effort to improve the organization's systems engineering. Several studies done on safety culture, a field similar to systems engineer, showed

that organizational commitment is a critical indicator when evaluating a cultural aspect of an organization (Alnoaimi, 2015; Alsowayigh, 2014; Fogarty, 2004). There are six items on the survey instrument used to measure the degree to which an individual desires to remain a part of the organization. Each of the six items were adopted from Fogarty (2004), Alsowayigh (2014), and Alnoaimi (2015).

3.5.1.3 Value of Systems Engineering

As mentioned previously SE culture is considered the values and beliefs of SE, this translates directly to confidence in the process element of SE Culture. Particularly, the perceived value of SE. It's easy to conceive that if employees believe that a process brings value, they are more likely to have confidence in that process. This is Value of SE is identified as a measure of SE Culture. There are three survey items that participants are asked to respond to that measures participants' perceptions of the values of systems engineering. These items were adapted from research questions developed by Eric C. Honour et al. (2004) investigating the value of systems engineering. Honour's studies have shown that it could be difficult to quantify the value of SE. Being intimately involved with the SE process and having experience with the SE process is important to measuring this construct, which is why survey items related to experience and role in SE are included as indicators for this construct.

3.5.1.4 Communication

Cooperation and teamwork has also been identified as an element of a strong SE culture. One of the underlying elements of cooperation and teamwork is communication. That is why Communication has been identified as a measure of SE Culture. This indicator measures the degree to which communication about systems engineering is expected in the organization. In particular, communication is examining if the SE practitioners are expected to communicate up, down, and across the organization. Research completed by Reigle (2015) show that lateral and vertical communication is a key characteristic for

measuring organizational culture in a high technology organization. Communication is critical to a project's success (Gill et al., 2005), was a major SE lessons learned theme identified in Chapter II. The survey instrument has six items for participants to respond to that measures communication. These items were adapted from Fogarty (2004), Alnoaimi (2015), and Zheng (2005).

3.5.1.5 Systems Engineering Culture

As identified in Chapter II, Systems Engineering culture is described as the values, beliefs, and normal practices of an organization, which facilitates systems engineering. SE Culture is described by numerous researchers as an enabler of systems engineering. The literature review completed in Chapter II identified that a healthy systems engineering culture is strong in the following elements:

- Leadership
- Trust and morale
- Cooperation and teamwork
- Empowering employees
- Confidence in the processes and practices
- Job security

For this study, the systems engineering culture construct represents the belief, values, and assumptions of the organization as it relates to systems engineering. Systems engineering culture is hypothesized to influence systems engineering support and systems engineering rigor.

3.5.1.6 Planning

The "Planning" indicator measure the degree to which the planning of systems engineering occurs. The elements of systems engineering planning that is being measured are: establishment of a SE infrastructure, SE approach (or model), how the technical effort will be controlled and managed, timing of the plan, and how the different technical disciplines are integrated. The first step program management

should take before implementing systems engineering, is planning. In most organizations, this is documented in a Systems Engineering Management Plan (SEMP, also called a Systems Engineering Plan or SEP). A well-written SEMP provides guidance to the project on how the technical portion of the project will be organized, managed, and executed and managed (INCOSE, 2011; NASA, 2007). A good SEMP also provides guidance on the how systems engineering is performed in the organization.

The literature review identified planning as a CSF for project management, which is also applicable to systems engineering. Planning is a critical aspect of management that is crucial to project success (Belassi & Tukel, 1996; Fortune & White, 2006; Müller et al., 2012; Randt et al., 2014; Shenhar et al., 2002; Slevin, 1987; Westerveld, 2003). Two of the major SE best practices themes identified during the literature review was that establishing the SE infrastructure in the organization is critical, and that the SEMP should be implemented as early as possible. To execute both of these SE best practices, would require planning by program management. There are five survey items that measure the participants' perception of the degree to which systems engineering planning has occurred in the organization. These survey questions were adapted from systems engineering planning research done by NASA (2007) and INCOSE (2011).

3.5.1.7 Personnel

The Personnel construct is made up of two factors: human capital and the training provided to them. Personnel measure is used to assess the human capital resources that are provided for systems engineering implementation. During the literature review sufficient staff, and well-allocated resources were identified as three of the top critical success factors of project management. Given project management's close relationship with systems engineering, it's reasonable to conclude that these factors can be applied to systems engineering as well. One of the SE best practices established by world leading

SE organizations, established that “The people are the primary resource for successfully developing a system”. Research conducted on management commitment and software process improvement determined that the primary commitment required from management is the providing adequate resources (Abrahamsson, 2000). Organizations not committed to a process or project usually dedicate little resources toward the project and usually do not focus on it.

During the literature review in Chapter II, systems engineering competencies was identified as a systems engineering enabler. Systems engineering competencies is described by some as the measure of the organization to appropriately apply personnel skills in order to successfully execute systems engineering. The SE competencies helps the organization to understand what training is required to successfully implement systems engineering. The Personnel construct also measures the dimensions of the organization’s systems engineering training. Survey participants are asked to respond to three survey items that measure the dimensions of the systems engineering training.

3.5.1.8 Tools and Infrastructure

Tools and infrastructure was identified by INCOSE (2011) and SEBoK authors (2016) as one of the primary enablers of systems engineering in an organization. Tools refers to the instruments provided by the organization to execute the systems engineering process. Infrastructure refers to the background or framework in which the tools are applied. Particularly, the infrastructure refers to the SE life-cycle model the organization employs. Tools and infrastructure factor measures the survey participants knowledge of the organization’s systems engineering tools and infrastructure provided by the organization to execute the systems engineering process. Survey participants were asked to respond to four survey items that measure the dimensions of tools and infrastructure.

3.5.1.9 Control and Assessment

Leading systems engineering organizations identify assessment and control as an important aspect of implementing SE. This factor measures the extent to which launch vehicle organizations are implementing control and assessment of their systems engineering. Systems engineering standards from organizations such as ISO (2007), IEEE (2008) and INCOSE (2011) identified four items needed for successful assessment and control of the systems engineering process. These four dimensions were identified during the literature review in Chapter II. The four survey items participants were asked to respond to measured respondents knowledge of control and assessment of systems engineering in their launch vehicle organization, were derived from the four dimensions identified by ISO, IEEE and INCOSE.

3.5.1.10 Systems Engineering Support

The “Systems Engineering Support” construct is used to evaluate the level of support that the organization is providing for systems engineering. The literature review completed in Chapter II, identify appropriate tools and infrastructure, timely planning, and appropriate personnel as systems engineering best practices (Blair et al., 2011; Bruff, 2008; Gill et al., 2005; Kaskowitz, 1990; NASA, 2007; Slegers et al., 2012). Similarly, the critical success factors for a project that the literature review identifies are: sufficiently allocated resources, qualified and sufficient personnel, effective control and maintenance, and adequate training. The systems engineering best practices and project management critical success factors both identify aspects of systems engineering support as being critical for project success. Allocation of resources and personnel, tools and infrastructure, training, control and assessment, are all components the organization can provide to support the systems engineering process.

3.5.1.11 Systems Engineering Rigor

The “Systems Engineering Rigor” construct is used to evaluate the level of scrupulous adherence to the systems engineering process. Upon completing research on launch vehicle failures, Newman (2001) described “rigorous systems engineering” as a high reliability trait an organization exhibited by implementing strong processes to circumvent human error and latent hardware and software defects. “Anything less than the full measure of systems engineering rigor will expose the project to failure” (Newman, 2001). Goldberg (2009) described engineering rigor as being rigorous in applying a set of established laws or principles. Goldberg’s definition of rigor specifically described in systems engineering, would be defined as rigorously applying established systems engineering process and principles. In 2007, a group of researchers from Case Western Reserve University conducted a study on process compliance and determined that failure to adhere to documented processes can lead to workarounds, which can have unintended consequences and lead to system failure. In addition, their research determined that failure to adhere to processes can also lead to organizational drift. Adherence to documented processes are critical to process improvements as well (Berente, Ivanov, & Vandenbosch, 2007).

“Manufacturing Issues”, “Integration and Test Issues”, and “Operation Issues” are three variables that measure the frequency and severity of launch vehicle issues experienced by an organization. Research conducted by several researchers identified systems engineering deficiencies and lack of systems engineering rigor as a contributor to launch vehicle problems (Chang, 1996; Harland & Lorenz, 2005; Isakowitz et al., 2004; Leung, 2014; Newman, 2001). Launch vehicle issues generally occur in either the design phase, manufacturing phase, integration and test phase, or operations phase of the systems engineering life cycle. Since design issues typically manifest during the manufacturing, integration and test, or operations phase, a variable for the design phase was not created. Survey items

focus on the severity and frequency of the launch vehicle issues in the manufacturing phase, integration and test phase, and operations phases to measure SE Rigor.

3.6 Pilot Survey Study

Pilot studies are an excellent planning tool used by many researchers. Leedy and Ormrod (2013) define a pilot study as an exploratory investigation performed by a researcher to test particular procedures, instruments, or methods. “A brief pilot study is an excellent way to determine the feasibility of your study”, (Leedy & Ormrod, 2013). The value of performing a pilot study is the lessons learned from the pilot survey that will be used to refine the research methods and procedures for more complex cases (Chenail, 2011; Yin, 2009).

As suggested by Leedy and Ormond, a pilot survey was conducted as part of this research. The survey instrument was included in the pilot study. The focus of performing this pilot study was to identify any lessons learned and areas of improvement in the research methodology and survey instrument. Once this information was collected, it was used to refine the survey instrument.

Data collected from the pilot study was subjected to the data processing techniques identified as part of the planned research methodology of this study. This was done to ensure the planned methodology could adequately analyze the data. Any data analysis results was reviewed with stakeholders and colleagues to determine the validity of the results. The results of the pilot study alone was not used to validate hypotheses of this research project. Lessons learned resulting from the pilot study that was determined to be value added improvements were used to revise the survey instrument. The pilot study results were recorded and kept for record keeping, but are not published.

3.7 Validity of Research Methodology

Leedy and Ormrod (2013) define validity of the research project's "accuracy, meaningfulness, and credibility". Gauging the validity of the research methodology is a critical part of research. Any research endeavor deficient in validity would be thought of as yielding questionable results, which could lead to improper utilization of results (Creswell, 2014; Valerdi & Davidz, 2009). Studies done by researchers such as Yin (2009) and Leedy and Ormrod (2013) suggest that the validity of research methodology can be assessed through the following areas: construct validity, internal validity, external validity, and reliability.

3.7.1 Construct Validity

Construct validity can be defined as how well the research project is measuring the concept that is being studied (Creswell, 2014; Valerdi & Davidz, 2009; Yin, 2009). This is a very important concept for understanding the quality of the research project. Valerdi and Davidz (2009) point out that construct validity can be particularly problematic in the systems engineering field due to lack of a consistent systems engineering definitions across the industry. To mitigate this, researchers study multiple projects across a variety of organizations to gain construct validity through commonalities found in the constructs of these various organizations. Allowing stakeholders to review the research results to provide feedback on how concepts are being evaluated provides further confidence in construct validation. In addition, collecting data from multiple data sources within each organization, increase internal validity of the research by allowing the researcher to identify common themes (Yin, 2009). Converging on common constructs provides a research confidence that the observations are real and not simply an artifact of the data collection methods.

3.7.2 Internal Validity

Internal validity can be defined as how well the research design will allow the researcher to draw accurate conclusions about causal relationships. One could also consider internal validity the likelihood of ruling out variables not pertinent to the research (Creswell, 2014; Leedy & Ormrod, 2013; Valerdi & Davidz, 2009; Yin, 2009). When there is a high likelihood of ruling out extraneous variables, the research project is considered to have a strong internal validity. Triangulation through the use of multiple sources of data is a common method used to improve internal validity. Multiple data sources are used with the expectation that the data will converge on a common construct (Creswell, 2014; Leedy & Ormrod, 2013; Yin, 2009). This is the approach that this research utilized to improve internal validity. Data was collected through surveys from a wide variety of participants.

3.7.3 External Validity

External validity is described as the ability to apply research results outside of the study (Creswell, 2014; Leedy & Ormrod, 2013; Valerdi & Davidz, 2009). Simply stated, how well the results can be used outside of the research project. Valerdi and Davidz (2009) point out that external validity can be problematic within systems engineering field, since systems are adapted to their application which can make it difficult to apply in a context outside of what the research project was designed for. Valderdi states that to mitigate these issues, choosing an adequate sample size, using a variety of research methods, and using field research.

To improve external validity, it is suggested to use an adequate samples size. The survey instrument was able to reach a large population. An appropriate quantity of surveys was distributed to achieve an adequate sample size. The appropriate sample size for this study is discussed in detail in Section 3.8.1.4.

3.7.4 Reliability

Researchers describe reliability of a research project as the degree to which a research projects design and methodology can be repeated yielding the same results (Creswell, 2014; Thayer-Hart, Elver, Schaeffer, & Stevenson, 2010; Yin, 2009). The objective of reliability is to reduce the amount of errors and biases of the research. Since a single researcher was responsible for data collection and analyses of this research project, there could be some concerns about reliability. Reliability concerns about a single research were mitigated by employing reliability best practices recommended by Yin (2009) and Chenail (2011).

As recommended by Yin and Chenail, all procedures are well documented. This would allow any subsequent researcher to repeat the work of this study. Well-defined methods and procedures reduces variability in the results of the repeated research thereby demonstrating reliability (Yin, 2009). To ensure participants anonymity and confidentiality, no personal or organization identifiable information was collected and results have been aggregated. This could raise questions about the reliability of this study since organizations and participants cannot be directly identified from the data, this could be a barrier to reproducing the research (Chenail, 2011).

Reliability in the survey questionnaire is critical to improving the overall reliability of this research project. To improve reliability in the survey, questions were carefully considered to remove any ambiguity within the survey questions so that each subject interpreted the survey questions the same way (Thayer-Hart et al., 2010). In addition, reliability of the survey instrument was calculated using the survey data. Unfortunately, the survey had to be issued prior to being able to calculate the survey reliability using Cronbach's Alpha. Cronbach's Alpha is a reliability statistic that can be calculated based on the internal consistency of the survey data and is used as a reliability indicator of the survey instrument (Santos, 1999). From the data collected, indicators are grouped according to their association to a construct, and Cronbach's Alpha is calculated. If a Cronbach's Alpha is calculated that shows

undesirable reliability for an indicator, then that indicator was considered for removal and was not recognized as a useful indicator of the construct.

3.7.5 Potential Sources of Bias

If a researcher is to consider the reliability of a research project, research bias must be acknowledged. Given human nature, and the environment we live in, it is almost impossible to conduct research without any exposure to bias. Bias in research can be considered an influence or condition that misconstrues the data (Leedy & Ormrod, 2013). Potential sources of bias in this research project have been identified, and mitigations for each potential source have been implemented.

The first potential source of bias identified, briefly mentioned earlier in this chapter, is the preconception bias. Yin (2009) identified that researchers are prone to bias toward a preconceived position. This type of bias is also called confirmation bias by some researchers (Chenail, 2011; Leedy & Ormrod, 2013; Rabin & Schrag, 1999). Becker (1958) suggested that the reason researchers are prone to preconceived bias is because the research must have an understanding of the phenomenon being studied beforehand. Particularly in my case, I have worked in the systems engineering field for over 15 years and have personally conducted systems engineering evaluations, so there is a potential for preconception bias. As suggested by Burnard (1991) and Yin (2009), the potential for preconception bias has been mitigated by reporting preliminary findings to at least two colleagues to produce contrary findings. If the colleagues can document findings contrary to the preliminary findings, then the probability of preconception bias has been reduced (Yin, 2009). Rabin and Schrag (1999) suggest that collecting data from multiple sources helps to reduce the risk of preconception bias. In this study, data was collected from many different organizations as well as different people associated with the systems engineering implementation via surveys.

The next potential source of bias is from survey statements. Bias could exist in the survey statements through the terms used in the statements as well as the way the statement is worded. The use of terms unfamiliar or wording of survey statements could lead to “inappropriate” responses. Although the use of unfamiliar terms or wording, are not biases, they can result in biased responses (Malhotra, Hall, Shaw, & Oppenheim, 2004). To reduce the chances of this type of bias, survey statements should use plain or common language (Malhotra et al., 2004; Thayer-Hart et al., 2010). The survey statements of this study used plain English when appropriate and language consistent with INCOSE, NASA, and SEBoK systems engineering handbooks when required. In addition, survey statements were reviewed by an independent third party to mitigate this bias. A third party examined survey statements to ensure that terms are unambiguous and do not lead the respondent in anyway. A pilot study was also implemented to provide an additional opportunity to receive feedback and implement further refinement of survey statements.

Sample selection is another potential source of bias. Sampling bias is described as being present if the target population is not accurately reflected in the sample. If certain members are either underrepresented or overrepresented in the target population, the sample is considered biased (Taylor-Powell, 2009). In order to avoid this type of bias, Myers and Newman (2007) suggests that respondents at various levels of the organizations be surveyed to mitigate this potential bias. For this research project, various participants in the system engineering process as well as participant in various organizations were surveyed to address any sampling bias. Taylor-Powell (2009) also stresses that it’s important to identify the differences between respondents when data is being reported. For this research, differences between respondents is carefully documented and identified.

3.8 Data Collection and Analysis

One of the great champions of the quality movement, W. Edwards Deming, once said, “Without data, you’re just another person with an opinion” and “In God we trust; all others bring data.” Data is one of the most critical products of any research project. Leedy and Ormrod (2013) described data as the pieces of information about a phenomenon. And that the path to the underlying truth runs through the data. This is what makes data collection and analysis a critical part of research. This section of the research describes how the data is collected, documented, and analyzed.

The goal of data collection is to gather information to help the researcher answer the research questions (Leedy & Ormrod, 2013). More specifically, the goal of the data collection and analysis is to compile information relevant to the constructs of this research project to determine the validity of the hypotheses. This phase of the research was made up of four parts. As stated in previous sections, the data collection methods utilized a survey instrument. An overview of the method is listed in Table 3.8-1.

Table 3.8-1: Data Collection Approach

Data Collection Approach	Data Source	Objective
Surveys	Systems engineering practitioners, managers, and participants within the organization	Measure the constructs identified and examine the relationship amongst the constructs identified

3.8.1 Survey Process

A survey instrument was the primary tool for collecting data in this study. A survey was used to reach a much wider population compared to face-to-face interviews and case studies. The survey is used

to collect data about the trends, opinions, and other information of the much larger population as they relate to the hypotheses of this research by studying a subgroup of the population. Surveys are frequently used in this manner for research to provide this type of data (Creswell, 2014; Leedy & Ormrod, 2013).

The survey development process implemented for this research is as follows:

1. Review survey examples from similar or related studies
2. Select the survey population
3. Develop the survey
4. Pilot the survey and integrate findings into survey
5. Administer the revised survey
6. Collect and analyze responses
7. Test the research hypotheses

This survey development methodology was adopted from systems engineering related research completed by Kludze (2004), Bruff (2008), Elm et al. (2008), and (Bjorn, 2012).

3.8.1.1 Review of Survey Examples from Similar Research

Survey examples from research conducting within the systems engineering field were sought. The survey examples that targeted similar populations and similar types characteristic were desired. These survey examples aided in identifying good practices and lessons learned related to survey development in this field. There were several survey examples that were found during the review of literature.

The first survey example examined was from doctoral research completed at George Washington University. The research investigated the impact of systems engineering at NASA (Kludze, 2004). The survey targeted systems engineering practitioners and managers. The survey for this research used a combination of 5-point Likert scale and multiple-choice questions.

The next survey example reviewed was another doctoral research paper completed at Walden University by Bruff (2008). Bruff's research investigated using systems engineering best practices as a measure of successful outcomes in selected DoD aerospace programs. The survey targeted systems

engineering practitioners in the government, as well as government contractors and subcontractors.

Bruff's survey largely used a 4-point Likert scale with a few free responses and multiple choice questions.

The third survey example analyzed was from research done by the Software Engineering Institute and National Defense Industry Association. The focus of this research was to investigate the effectiveness of systems engineering (Elm et al., 2008). The survey questionnaire used in this research mainly used a 4-point Likert scale with a few multiple choice and free response questions. Systems engineer managers and practitioners in the government and their contractors was the population chosen for this survey.

The final survey example examined was from doctoral research completed at the University of Central Florida. The research investigated the critical success factors of implementing a new acquisition strategy of complex systems in the DoD (Bjorn, 2012). The population selected for this research were managers, systems engineers, and subsystem engineers. A combination of 4-point Likert scale, multiple choice, open answer questions were used for the survey.

3.8.1.2 Administering the Survey

To reach the largest population for the survey, the most practical distribution method is to use email and online tools (Leedy & Ormrod, 2013). An email was distributed to the survey sample population, which contains a link that takes the respondent to the survey instrument online. The survey instrument is hosted on-line by Google Forms. Google Forms provides tools for creating the various types of survey questions as well as collecting the data. The surveys were emailed to participants after receiving Institutional Review Board (IRB) approval and contains a cover letter assuring respondents that data provided is used for the sole purposes of the study and individuals responding to the survey will remain anonymous. In addition, several copies of the survey was printed out and distributed by hand at

two technical conferences attended by the target audience of this research. The surveys were collected at the end of both conferences.

3.8.1.3 Survey Population Selection

A population that has knowledge of the systems engineering process and how systems engineering is implemented in the launch vehicle industry was critical. Subjects with this knowledge provided valuable insight into the hypotheses and constructs identified in this research. The statements of the survey aimed to identify the population's perceptions of systems engineering culture, support, and rigor in the launch vehicle industry. The survey targeted people that play a role in or manages the systems engineering process. The survey population selection included: project managers, systems engineers, subsystem engineers, technical managers, program managers, and any other person that played a role in the systems engineering process. There were no restrictions on the size of the organizations selected for the survey. Individuals involved in the systems engineering process within launch vehicle organizations in the United States were targeted for the survey to avoid any language barriers.

3.8.1.4 Sample Size

Sample sizes play a significant role when conducting research. The general rule of thumb when conducting an empirical study is that the larger the sample size, the better (Leedy & Ormrod, 2013). This is the general rule when conducting many statistical studies. Structural equation modeling researchers suggest that a minimum sample size of 200 is adequate to reduce biases to an acceptable level (Boomsma & Hoogland, 2001; Fabrigar & Wegener, 2011; Kline, 2011). The target population of this study has been estimated to be over 2000. Therefore, a 10 percent response rate was adequate to achieve the desired minimum sample size. Organizational research studies on survey response rates done by Baruch and Holtom (2008) show that the average response rate for individuals are 52.7 percent with a standard

deviation of 20.4 and responses from organizations are 35.7 percent with a standard deviation 18.8. Based on Baruch and Holtom's research, assuming a survey response rate of 10 percent was conservative.

3.8.1.5 Survey Development

The survey instrument of this study was designed to collect information from the target population. The survey aimed to gather information about the respondents' background, perspective about the various constructs of the research model. The process adapted from Bjorn (2012) used for developing the survey statements is illustrated in Figure 3.8-1.

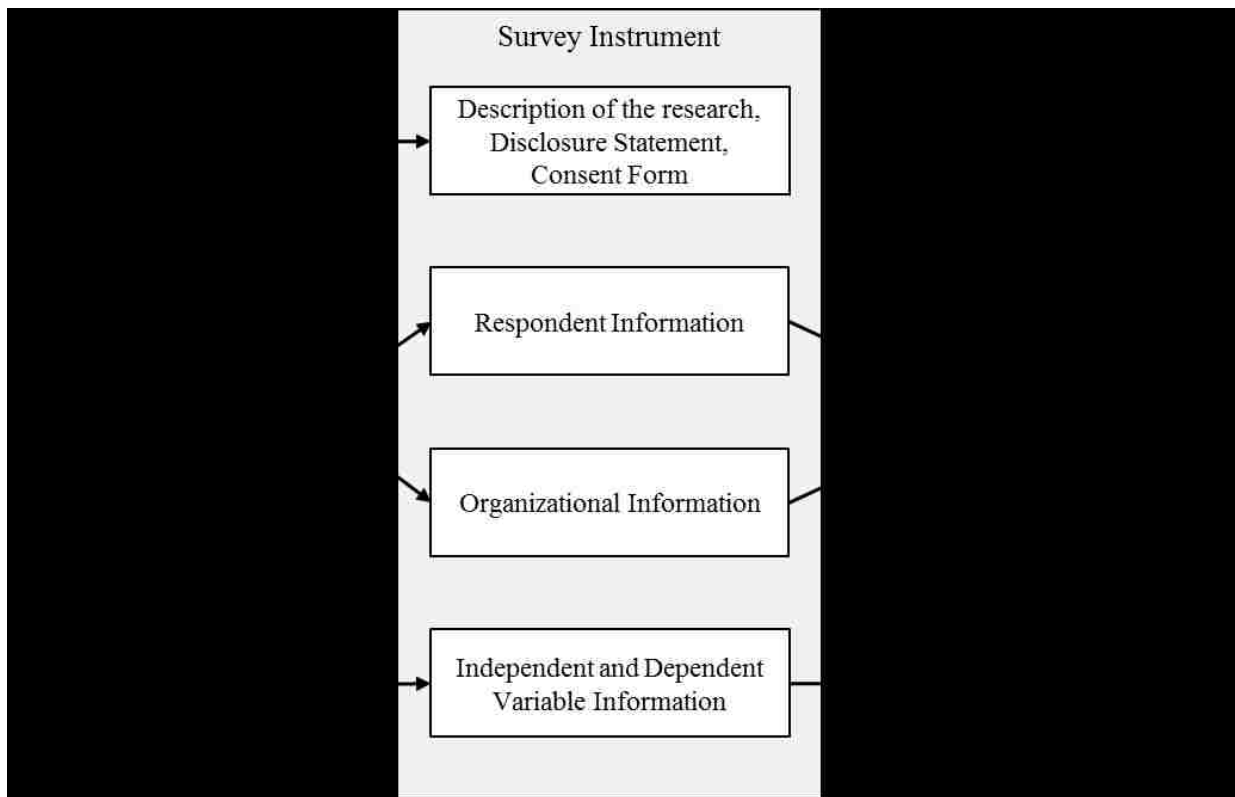

Figure 3.8-1: Survey Development Process

The first part of the survey instrument contained a description of the research being conducted, followed by a disclosure statement and a form requesting the respondent's consent. The second part of survey focused on the background of the respondent and the organization that he or she worked in. These

include statements about the respondent's roles and responsibilities, relevant experience, and information about the organization. The survey background questions were used to determine if the respondent and the respondent's organization reflected the target population. The background survey questions were multiple choice and free response questions.

The core of the survey contains questions that aimed at collecting data on the constructs of the research model. The survey statements of each section evaluated the dimensions of each research model construct. Since these constructs need to be evaluated on a continuum, a rating scale is recommended for use in the survey (Leedy & Ormrod, 2013). A 5-point Likert scale was used for non-demographic questions of the survey. The scale ranged from 1 (Strongly Disagree), 2 (Disagree), 3 (Neutral), 4 (Agree), to 5 (Strongly Agree). The rating scale used in this research is contained in Table 3.8-2. This survey format is similar to survey format used in systems engineering effectiveness studies completed by Kludze (2004), Bruff (2008), and Elm et al. (2008) that were examined during the literature review in Chapter II.

Table 3.8-2: Survey Likert Scale

Score	Response
1	Strongly Disagree
2	Disagree
3	Neutral
4	Agree
5	Strongly Agree

3.8.1.6 Piloting the Survey

The survey was piloted before being officially administered to the survey sample group. The survey was given to a group of systems engineering practitioners that are independent of the survey population to evaluate and provide feedback on the survey instrument. A pilot group can identify ambiguity, misleading questions, and if the instrument is actually measuring what is intended to be measured (Leedy & Ormrod, 2013). This allows for a much more effective survey instrument to be administered to the target sample population. Feedback from the pilot group was incorporated into the survey instrument as necessary before being administered to the target survey population.

One of the goals of this survey instrument was to keep the time required to complete the survey to less than one hour. Feedback from survey respondents that Elm et al. (2008) received on their systems engineering survey research showed that individuals are less likely to respond to the survey if it takes more than an hour to complete. This information was provided to the pilot team to provide feedback on the length of time it took to complete the survey and identify if the survey response time exceeds an hour. The pilot study team determined that the survey took approximately 10 minutes to complete.

3.8.2 Survey Data Analysis

There are several steps involved in analyzing survey data. The survey data analysis can be divided into three phases: survey response validation, survey reliability analysis, and data analysis. The process used to analyze the survey data is illustrated in Figure 3.8-2.

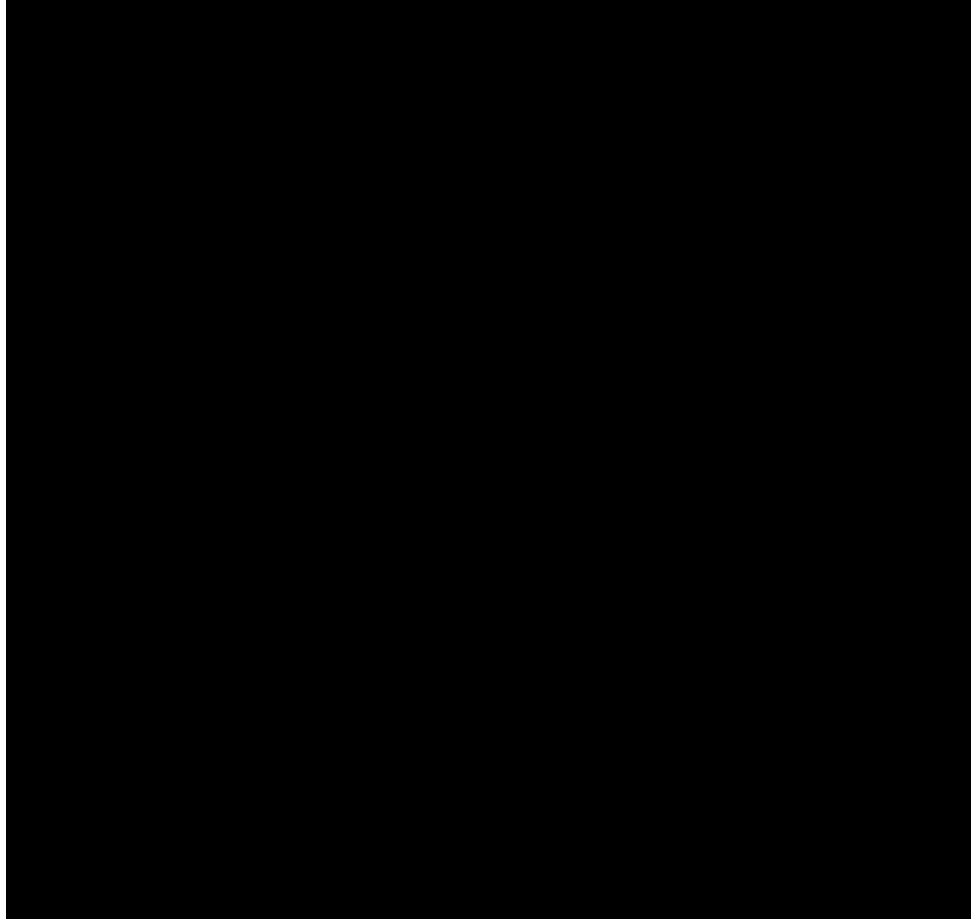

Figure 3.8-2: Survey Data Analysis Process

3.8.2.1 Survey Response Validity

Once survey responses were received, the first step was to validate the response. Surveys were examined to ensure that each survey statement received a valid response. Any survey that was missing one or more responses, were considered invalid and were filtered out but archived for record keeping purposes. Including surveys in the data set with missing responses would lead to different sample sizes for the constructs during data analysis, which are not suitable for correlation or regression data analyses (Centre, 2001; Kitchenham & Pfleeger, 2003). As the Statistical Service Centre (2001) and Kitchenham

and Pfleeger (2003) suggests, the invalid surveys were examined, to determine if any information can be inferred from the missing responses.

3.8.2.2 Survey Reliability Analysis

After filtering out invalid surveys, the survey instrument was evaluated to determine the reliability of the survey instrument. When survey questions are able to return a stable response, the survey instrument is determined to be reliable (Santos, 1999). To test the reliability of this survey instrument, Cronbach's alpha was calculated for each variable of this study. Cronbach's alpha values are evaluated to determine the reliability. If a survey question yields a low alpha value, the question was evaluated to determine if it was a reliable indicator of its associated construct. During this evaluation, the question was examined to determine if it should be associated with another construct or if it was invalid and should be removed. In confirmatory factor analyses, this is accomplished through calculating Cronbach's alpha for the measurement model which is discussed in detail later in this chapter.

3.8.2.3 Data Analysis

After the survey responses have been validated and the survey instrument was determined to be reliable, analyses investigating the constructs of the research can begin. Analysis of the survey data consisted of the following: generating descriptive statistics, performing a confirmatory factor analysis, structural equation modeling, and hypothesis testing. First, descriptive statistics of the data were generated. Next, a confirmatory factor analysis of the data was performed to develop the measurement model. The third part was to perform structural equation modeling, which tested the structural paths of the constructs in the model. Then finally, performed hypothesis testing. Researchers such as Bjorn (2012), Alsowayigh (2014), and Alnoaimi (2015), followed this data analysis process in systems engineering and safety culture research.

3.8.2.3.1 Descriptive Statistics

The first step in the detailed data analysis process was to generate a set of descriptive statistics. The descriptive statistics helped to characterize the data collected by providing information such as sample mean, variance, standard deviation, etc. Frequency tables of the control variables were also used to show the number and percentages of managers, systems engineers, sub-system engineers, analysts, experience, or industry. In addition to the descriptive statistics, results were plotted to provide a visual representation of the survey results. The graphs were reviewed to determine if any observations about the results can be made visually.

3.8.2.3.2 Confirmatory Factor Analysis

Next, an analysis evaluating the relationships between the variables and the constructs was completed. Since adequate theories and observations existed in the area of systems engineering, a confirmatory factor analysis (CFA) was used. A CFA is a data analysis technique used to evaluate the relationships between variables and constructs based on the researcher's knowledge, theories, or observations (Byrne, 2016; Suhr, 2006). Performing a CFA is appropriate when research in the area is relatively mature and basic measurement questions have been resolved. The CFA was used to validate the concept model. It provided an estimate of the correlation between the constructs and variables, which is used to evaluate the construct validity (Byrne, 2016; Kline, 2011).

In the CFA, responses to the survey questions were considered to be the observed variables, and were represented by rectangles in the CFA model. The unobserved constructs that are the primary targets of the study, are considered to be latent variables, and are represented by ovals in the model. Latent variables can either be exogenous (independent) or endogenous (dependent). The endogenous latent variables are not affected by the other variables in the model, whereas, the exogenous latent variables are affected by other variables in the CFA model. The arrows of the CFA model represent the relationships

between the variables. Each relationship (arrow) is assigned a factor loading. The factor loading is the value representing the degree to which an observed variable can predict the latent variable. The stronger the relationships between observed and latent variables are, the higher the factor loading value will be. Research completed by Tabachnick and Fidell (2013) suggests the factor loading interpretation identified in Table 3.8-3.

Table 3.8-3: Factor Loading Interpretation

Factor Loading Range	Variance accounted for	Interpretation
0 – 0.32	10%	Not interpreted
0.32 – 0.45	10%	Poor
0.45 – 0.55	20%	Fair
0.55 – 0.63	30%	Good
0.63 – 0.71	40%	Very good
> 0.71	50%	Excellent

Early steps of performing a CFA is developing and evaluating the individual measurement models for each latent variable. The measurement model is the part of SEM that shows the relationship between the observed variables (indicators) and the latent variables. Evaluating the measurement model is widely considered by SEM researchers to be a method to avoid model identification problems (Hoyle, 2012; Kline, 2011; Schumacker & Lomax, 2010). As part of evaluating the individual measurement models, Cronbach’s alpha was calculated to determine the reliability of the survey instrument for that construct (latent variable). A Cronbach’s alpha greater than 0.70 is considered to be adequate reliability for a CFA (Hair, Black, Babin, & Anderson, 2014). If during this process an observed variable is considered to be unreliable, it was considered for removal.

Studies completed by MacCallum, Widaman, Zhang, and Hong (1999) and MacCallum, Widaman, Preacher, and Hong (2001) shows that adequate sample sizes for factor analyses has little to do with the ratio of sample size to variables. Many researchers follow a general rule of using a sample size (N) of two and a half times the number of variables in the study. For this research, every effort was made to achieve a sample size to number of variables ratio of 2.5, however is not required to complete a factor analysis. If the sample size achieved does not provide adequate degrees of freedom due to errors on individual questions, a CFA is performed individually on each construct.

3.8.2.3.3 Structural Equation Modeling

Structural Equation Modeling (SEM) is a comprehensive statistical methodology that combines multiple regression, factor analysis, and canonical correlation (Hoyle, 2012; Tabachnick & Fidell, 2013). SEM uses various types of models to illustrate the relationships between the observed and latent variables and provides a quantitative test of the hypothesized model. It provides a method of testing the network or relationships between the variables (Schumacker & Lomax, 2010; Suhr, 2006). The structural equation model identified how well the data collected in this study supports the research model in Figure 3.4-1.

3.8.2.3.4 Testing Hypothesized Model

To determine how well the data supports the hypothesized model, the goodness of fit was examined. Upon completion of the CFA, model fit was evaluated using model fit indices. Model fit indices can be used to measure how well the model fits the data. Vandenberg and Scarpello (1990) recommends using multiple model fit indices to provide adequate support of model fitness. This study used four different model fit indices: chi-square, Comparative Fit Index (CFI), Tucker-Lewis index (TLI), and Root Mean Square Error of Approximation (RMSEA). These model fit indices are discussed in detail in Section 3.8.2.3.5.

If model fit indices showed an adequate model fit, hypothesis testing was then completed based on the results of the CFA. The factor scores produced from the CFA were used to test the hypotheses of the research. The factor scores provides an estimate of the weight (or loading) of the constructs on the CFA structural model based on the survey data. The factor loading from the CFA was used to test the hypotheses. Performing a CFA on the data collected in this study transforms the data collected by the survey into a format that can be used in hypothesis testing. The statistical analysis *IBM SPSS Amos* software is used to perform the CFA and structural equation modeling.

However, if indices did not show an adequate fit, and the CFA fails to identify significant factors between the paired constructs and variables, then an exploratory factor analysis (EFA) is completed. An EFA is used to examine potential relationships between a set of constructs and observed variables without any preconceived notions of relationships between the constructs and variables (Suhr, 2006). An EFA helps to identify the underlying construct structure. Results of any EFA completed would be used to update the concept model of this study if necessary.

3.8.2.3.5 Model Fit Indices

There were four model fit indices used to evaluate how well the models fit the data. The first was the chi-square (χ^2) index. The chi-square index is an indicator of how well the path model fits the data. This index also reflects the relationship between the correlation matrices of the original and reproduced path model. Since chi-square can be sensitive to sample size, SEM researchers suggest using a ratio of chi-square (χ^2) to degrees of freedom (df). A lower $\frac{\chi^2}{df}$ indicates a better fit of the model to the data. SEM researchers suggest that a $\frac{\chi^2}{df}$ value of 5 or less indicates a good fit (Hoyle, 2012).

Two other goodness of fit indices used were the Tucker-Lewis Index (TLI) and the Comparative Fit Index (CFI). The TLI and CFI are goodness of fit indices recommended by SEM researchers (Byrne, 2016; Hoyle, 2012; Schumacker & Lomax, 2010). Both of these indices provides a comparison of the

hypothesized model to the null model. In both the TLI and CFI a 0 indicates no fit and a 1 indicates perfect fit. Values between 0.90 and 0.95 are considered a good fit.

The Root Mean Square Error of Approximation (RMSEA) was the fourth model fit index used. RMSEA is an index that identifies the lack of model fit, where an RMSEA of 0 indicates a perfect fit. RMSEA can be considered the degree to which the model has been misspecified (Hoyle, 2012). A RMSEA value of less than 0.05 is considered a good fit. However, a RMSEA value between 0.05 and 0.08 is considered acceptable. RMSEA values between 0.08 and 0.10 are considered a mediocre fit. A value of 0.10 or greater would be considered a poor model fit (Byrne, 2016; Hoyle, 2012; Kline, 2011; Schumacker & Lomax, 2010).

CHAPTER IV: RESEARCH FINDINGS

This chapter discusses the findings based on analysis of the responses to the survey instrument. As described in Section 3.8.2, the data analysis has four phases. The first phase was to perform descriptive statistics analysis. In the second phase a confirmatory factor analysis of the data was performed to develop the measurement model. The third phase was to perform structural equation modeling, which tested the structural paths of the constructs in the model. Then finally, hypothesis testing was performed.

4.1 Descriptive Statistics Analysis of Control Variables

The target population of this study was launch vehicle organizations in the United States. The survey instrument collected demographic data such as job position(s), career level, type of experience, organization size, and type of organization. These are considered the control variables. There were a total of 210 respondents to the survey. However, seven survey responses had to be thrown out since the participant did not completely fill out the survey. As seen in Figure 4.1-1, of the 203 responses the majority of respondents (42.4%) identified as holding a systems engineer job position. There also appeared to be survey responses from a wide variety of job positions at varying levels of the organization. This variety of job positions addresses concerns of sampling bias.

The next few demographic categories covered: career level (years of experience), number of projects worked on, and if experience is with something other than launch vehicles. Approximately, 40.9% of survey respondents had more than 20 years of experience. Looking at the number of projects that the respondents participated in, 31% of respondents participated in 20 or more projects, however, the next largest group (24.1%) had only worked on 6-10 projects. The majority (71.4%) of respondents' experience was in the launch vehicle industry.

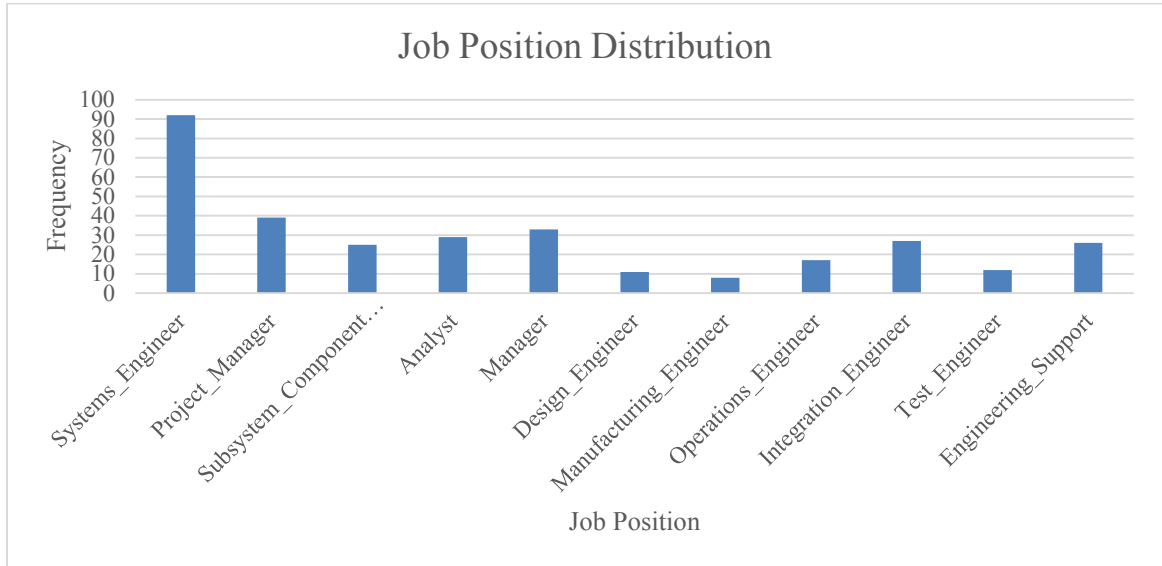

Figure 4.1-1: Job Position Distribution

Table 4.1-1: Job Position Frequencies

Job Position Frequencies

Job Position	Responses		Percent of Cases
	N	Percent	
Systems Engineer	86	27.7%	42.4%
Project Manager	39	12.5%	19.2%
Subsystem/Component Engineer	25	8.0%	12.3%
Analyst	28	9.0%	13.8%
Manager	33	10.6%	16.3%
Design Engineer	11	3.5%	5.4%
Manufacturing Engineer	8	2.6%	3.9%
Operations Engineer	17	5.5%	8.4%
Integration Engineer	27	8.7%	13.3%
Test Engineer	12	3.9%	5.9%
Engineering Support	25	8.0%	12.3%
Total	311	100.0%	153.2%

a. Dichotomy group tabulated at value 1.

Table 4.1-2: Demographics Descriptive Statistics

	N	Mean	Std. Deviation
Systems Engineer	203	.42	.495
Project Manager	203	.19	.395
Subsystem/Component Engineer	203	.12	.329
Analyst	203	.14	.346
Manager	203	.16	.370
Design Engineer	203	.05	.227
Manufacturing Engineer	203	.04	.195
Operations Engineer	203	.08	.278
Integration Engineer	203	.13	.340
Test Engineer	203	.06	.236
Engineering Support	203	.12	.329
Career Level	203	3.52	1.510
Number of Projects	203	3.00	1.584
Launch Vehicle Experience	203	.71	.453
Type of Organization	203	3.62	.667
Organization Size	203	2.53	.624

The survey collected information on the individual respondents as well as their organizations. The organizational information collected was organization size and type of organization. The majority (71.4%) of the survey responses came from participants that identified as working for a government agency. A little more than half (60.1%) of respondents identified as belonging to a large organization (1000 or more employees).

4.2 Testing Assumptions

Most analyses performed on statistical data assumes normality, linearity, homoscedasticity, and absence of multicollinearity. It is important for any statistical based research to check these assumptions

prior to executing statistical analyses. Failing to confirm these assumptions could lead to inferences that are less robust. Each of the four assumptions are evaluated to enhance the analysis. Below shows the variable abbreviations used for the observed variables.

Table 4.2-1: Variable Abbreviations

	<u>Variable</u>	<u>Abbreviation</u>
1	Top Management Support	TMS
2	Organizational Commitment	OC
3	Communication	Comm
4	Value of Systems Engineering	VSE
5	Control and Assessment	CA
6	Personnel	Per
7	Tools and Infrastructure	TI
8	Training	Tm
9	Planning	Pln
10	Manufacturing Issues	MI
11	Integration and Test Issues	ITI
12	Launch Issues	LI

4.2.1 Normality, Linearity, and Homoscedasticity Check

Normality is when each variable and each linear combination of variables has a normal distribution. Homoscedasticity is when there is uniform variances across all values of predictors. The normality, linearity, and homoscedasticity test can be completed by plotting the residuals. The residuals are the differences between the predicted and observed variables. A normality test was performed on the

data using *SPSS Regression*. In the normal P-P plot, if the data is normally distributed, the points will follow the normal line. In the residual scatter plot, if the data is homoscedastic, the data points will be equally distributed about the x- and y-axis. The results of the normality, linearity, and homoscedasticity checks and plots are summarized in Appendix C. All of the variables were found to be in violation of the normality, linearity, and homoscedasticity multivariate assumptions. This is taken in to consideration in the remainder of data analyses.

Many SEM researchers such as Kline (2011) and Hair et al. (2014) recommend using bootstrapping when data is not normal. Bootstrapping is a statistical process of resampling or replicating the data over a large number of samples (Byrne, 2016; Hair et al., 2014; Kline, 2011; Tabachnick & Fidell, 2013). Research completed by Byrne (2016) suggests that bootstrapping has little effect on factorial validity and validity can be achieved even though normality assumption is violated. None the less, bootstrapping was used during the SEM portion of the data analysis in Section 4.4 to bolster results.

4.2.2 Multicollinearity Assessment

One issue that can arise when performing a CFA is called multicollinearity. Multicollinearity is when one or more observed variables are strongly correlated. Highly correlated observed variables could mean that the two observed variables are essentially measuring the same thing. This could lead to under identification of the model. In researching multicollinearity, Tabachnick and Fidell (2013) suggests that a correlation above 0.90 to be high. A correlation of 0.90 was also considered as the cutoff for a highly correlated variables was used in similar research (Alnoaimi, 2015). Highly correlated observed variables may contain redundant information and may not be need in the analysis. A multicollinearity assessment was performed by constructing a correlation matrix of the indicators of each of the observed variables

using *IBM SPSS Correlate*. The correlation matrices can be found in Appendix C. A summary of the multicollinearity check can be found in Table 4.2-2.

A Pearson's Correlation matrix was generated for each of the observed variables. The correlation between each indicator of each observed variable was determined to be statistically significant for all indicators. The highest correlations were between TMS1-TMS2 and LI1-LI2 which were 0.867 and 0.886 respectively. There were no correlations that were greater than 0.90, which suggests that there is no multicollinearity amongst the indicators. Since all correlations shown to be statistically significant, and no evidence of multicollinearity, there were no indicators recommended for removal for the confirmatory factor analysis.

Table 4.2-2: Summary of Correlation Matrices Assessment

<u>Variable</u>	<u>Correlation of all indicators statistically significant?</u>	<u>Indicators with Correlation >0.90</u>
Top Management Support	Yes	None
Organizational Commitment	Yes	None
Communication	Yes	None
Value of Systems Engineering	Yes	None
Control and Assessment	Yes	None
Personnel	Yes	None
Tools and Infrastructure	Yes	None
Training	Yes	None
Planning	Yes	None
Manufacturing Issues	Yes	None
Integration and Test Issues	Yes	None
Launch Issues	Yes	None

4.3 Confirmatory Factor Analysis

Confirmatory factor analysis is the technique used to evaluate the relationships between the observed variables and the constructs. A CFA is used when some prior knowledge of the underlying relationship of the latent variables exist (Byrne, 2016). The prior knowledge of these underlying relationships were developed through the literature review completed in Chapter II. The CFA is one of the primary components of a structural equation model. Kline (2011) suggest the following steps for performing a CFA:

1. Specify the model
2. Determine if the model was identified
3. If model was adequately identified, determine if the model fit is adequate
4. If model fit not adequate, revise model to achieve better fit
5. If model fit adequate, validate the measurement model

The steps listed above were used for performing the confirmatory factor analyses in this study.

Specification of the model is representing hypotheses in the form of a measurement model. The measurement model illustrates the relationship between the observed variables (indicators) and the latent variable (T. A. Brown, 2006; Hoyle, 2012). The three primary constructs of this study are represented by three latent variables in the model: Systems Engineering Culture, Systems Engineering Support, and Systems Engineering Rigor. Each latent variable had three or more indicators (observed variables). In this study, Systems Engineering Culture is the exogenous variable and Systems Engineering Support and Systems Engineering Rigor are the endogenous variables. Each of the latent variables had multiple indicators. A measurement model was created for each latent variable.

The second step to performing a CFA is to determine if the model is identified. Model identification is considered to be when the analysis can identify a unique set of estimates for every model parameter (Byrne, 2016; Kline, 2011). The measurement models were evaluated using the *IBM SPSS Amos 25* software to determine parameter estimates. In some cases models had to be revised.

The third step was to evaluate model fit. As stated in the previous chapter, model fit was evaluated using chi-square, CFI, TLI, and RMSEA. The model fit was evaluated using the criterion outlined in Section 3.8.2.3.5. The initially proposed model is revised until adequate model fit is achieved.

In some cases, models had to be revised to achieve adequate model fit. Model revision was based on the following: statistical significance of indicator, modification indices, and covariance not accounted for. The first criteria used for revising the model is to identify factor loadings that are not statistically significant. A statistically significant factor loading was identified to be a factor loading that has a critical ratio magnitude greater than 1.96.

The next model revision criteria used was the modification indices. The modification indices identify the degree to which the hypothesized model is appropriately described (Byrne, 2016). A modification index value greater than 10 was determined to be an adequate candidate for modification

since making modifications based on a modification index of less than 10 would result in little change to the overall model fit (Byrne, 2016). Error covariance and cross-loading was identified in the modification indices. Research by Hair et al. (2014) suggests that when a variable consistently shows cross-loading that means it does not represent a distinct concepts and should be considered for deletion. Cross-loading was avoided whenever possible in this study.

The final criteria used for model revision is identifying covariance terms not well accounted, which was determined by examining the Standardize Residual Covariance Matrix. Any indicators that had large residuals in the matrix were candidates for removal since they are not adequately accounted for in the model. Residuals with a magnitude greater than 2.58 were considered to be large and a good candidate for removal (Byrne, 2016).

Research completed by Hair et al. (2014) suggests that ideally during model modification, a minimum of four indicators should be maintained per factor in the model. However three is acceptable to provide adequate model identification and minimum coverage of the construct. Hair also states that SEM is often completed with a single indicator representing a single factor. This study strived to maintain a minimum of three indicators per factor whenever possible.

Once adequate model fit was achieved, the next step was to validate the measurement model. The model was validated by assessing the internal consistency of the latent construct. This was achieved by evaluating the reliability of the survey instrument by calculating Cronbach's alpha for each of the measurement models. A Cronbach's alpha greater than 0.70 is considered acceptable reliability. *IBM SPSS Reliability Analysis* was used to calculate Cronbach's alpha.

4.3.1 Exogenous Variables

In this study, there was one primary exogenous variable. The construct represented by the latent variable was Systems Engineering Culture (SEC). SEC was conceptualized by four latent factors. SEC

was conceptualized by: Top Management Support, Organizational Commitment, Value of System Engineering, and Communication. A CFA was completed for each of the factors of Systems Engineering Culture to validate the measurement model of these constructs.

4.3.1.1 Top Management Support

Top Management Support consists of five indicators (TMS1 through TMS5). These indicators correspond to five survey instrument statements. The survey instrument used a 5-point Likert scale ranging from “Strongly Agree” to “Strongly Disagree”. The Top Management Support measurement model was validated by completing a CFA.

The first step of the CFA was to specify the model. The initial model that was specified can be seen in Figure 4.3-1. The next step was to determine if the model was identified. A CFA was ran on the proposed model, and the *IBM SPSS Amos 25* was able to determine a unique set of parameter estimates. Next model fit was evaluated using the criteria outlined in Section 3.8.2.3.5. All four of the model fit indices were outside of the desired ranges for the initial Top Management Support measurement model:

$\frac{\chi^2}{df} = 37$, TLI = 0.488, CFI = 0.744, RMSEA = 0.424. The inadequacy of the model fit meant that the model needed to be revised.

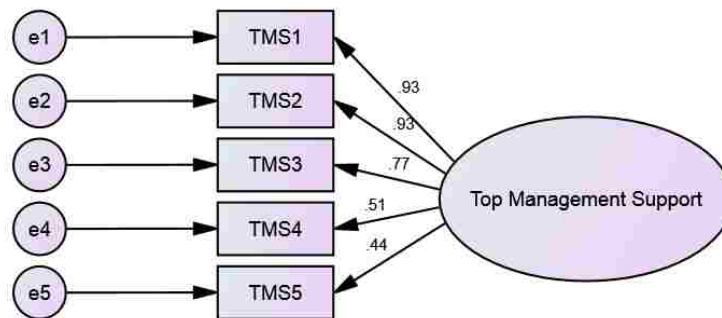

Figure 4.3-1: Initial Top Management Support Model

The first step in revising the model was to evaluate the significance in the factor loading. All indicators were statistically significant and had factor loading critical value magnitudes greater than 1.96. Also, the factor loadings had magnitudes of 0.44, 0.51, 0.77, 0.93, and 0.93. Based on the factor loading criteria identified in Table 3.8-3, all but TMS5 were fair or better. Since the factor loading for TMS5 was less than fair, it was a candidate for removal. Next, the modification indices were evaluated to identify what modifications can be made. The modification index showed a value above 10 for two covariance paths between e1-e5 and e4-e5. Next, the Residual Covariance Matrix was evaluated and there was a large residual covariance between TMS4-TMS5, which suggest that it was not adequately accounted for in the model. Since most of the model modification indicators centered on TMS5, it was removed from the model. The revised model is illustrated in Figure 4.3-2.

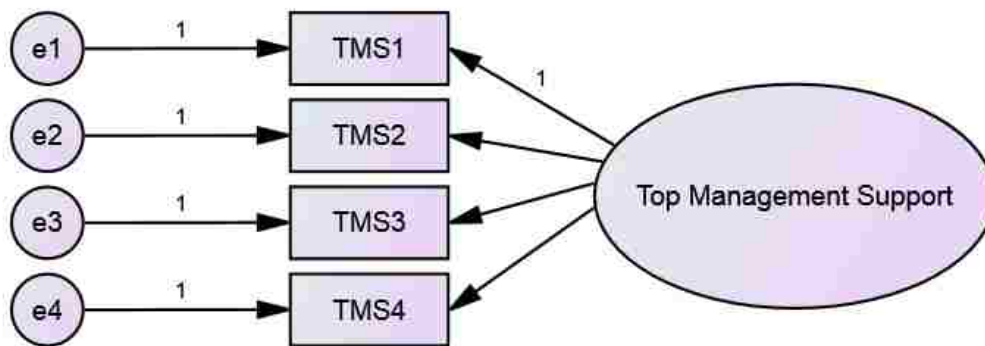

Figure 4.3-2: Revised Top Management Support Model

Table 4.3-1: Top Management Support Measurement Model Parameter Estimates

Indicator	Initial Model				Revised Model			
	Std. Estimate	S.E.	C.R.	P	Std. Estimate	S.E.	C.R.	P
TMS5 <--- Top Mgmt. Support	0.436	0.086	6.403	***	Deleted			
TMS4 <--- Top Mgmt. Support	0.514	0.078	7.855	***	0.488	0.078	7.427	***
TMS3 <--- Top Mgmt. Support	0.773	0.058	14.670	***	0.768	0.057	14.561	***
TMS2 <--- Top Mgmt. Support	0.930	0.048	21.769	***	0.928	0.049	20.989	***
TMS1 <--- Top Mgmt. Support	0.927				0.936			

A CFA was conducted on the revised Top Management Support measurement model. The model estimates can be found in Table 4.3-1. In the revised model, all factor loading estimates range from fair to excellent. Each factor loading estimate was statistically significant. The revised model had the following model fit index values: $\frac{\chi^2}{df} = 2.194$, TLI = 0.985, CFI = 0.995, RMSEA = 0.077. All model fit indices satisfy the model fit criteria showed a good fit for the revised measurement model. There was a substantial model fit improvement of the revised model compared to the initial model.

The final step in evaluating the revised model for Tom Management Support was to calculate Cronbach’s alpha. Cronbach’s alpha was calculated using *IBM SPSS Reliability Analysis*. Cronbach’s alpha for the revised Top Management Support model was 0.856. The 0.856 exceeds the recommended value of 0.7 indicating that there was good internal consistency and that the measurement construct was reliable.

4.3.1.2 Organizational Commitment

Organizational Commitment consisted of six indicators (OC1 through OC6). These indicators correspond to six survey statements. As previously stated, the survey instrument used a 5-point Likert

scale ranging from “Strongly Agree” to “Strongly Disagree”. The Organizational Commitment measurement model was validated by completing a CFA.

The first step of the CFA was to specify the model. The initial model that was specified can be seen in Figure 4.3-3. The next step was to determine if the model was identified. A CFA was ran on the proposed model, and the *IBM SPSS Amos 25* was able to determine a unique set of parameter estimates. The parameter estimates can be found in Table 4.3-2. Next model fit was evaluated using the criteria outlined in Section 3.8.2.3.5. The model fit indices for Organizational Commitment were: $\frac{\chi^2}{df} = 1.929$, TLI = 0.978, CFI = 0.978, RMSEA = 0.068. All of the recommended model fit criteria was satisfied which demonstrated a satisfactory model fit, therefor, the model did not need to be revised.

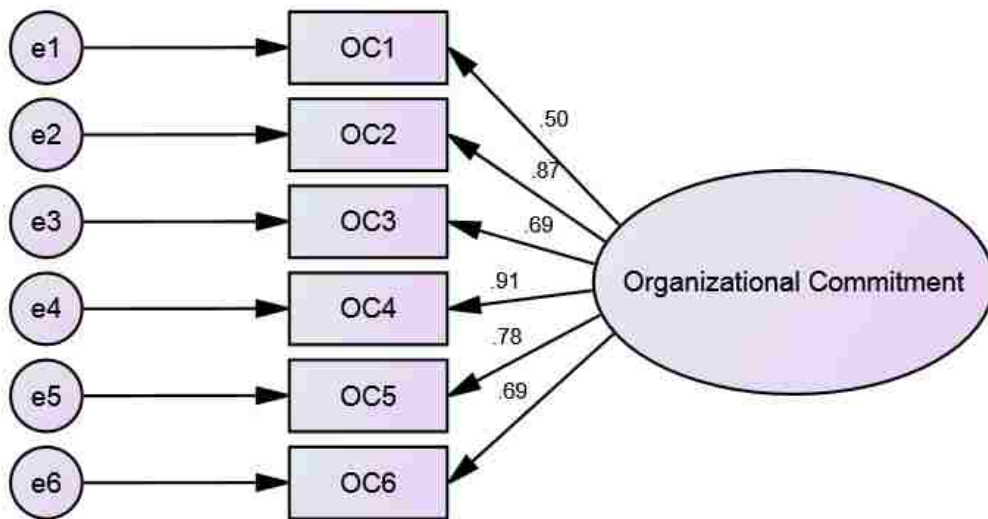

Figure 4.3-3: Organizational Commitment Measurement Model

Table 4.3-2: Organizational Commitment Measurement Model Parameter Estimates

Indicator	Standardize Estimate	S.E.	C.R.	P
OC6 <--- Organizational Commitment	0.687	0.379	6.687	***
OC5 <--- Organizational Commitment	0.785	0.251	7.085	***
OC4 <--- Organizational Commitment	0.906	0.307	7.423	***
OC3 <--- Organizational Commitment	0.688	0.307	6.657	***
OC2 <--- Organizational Commitment	0.868	0.350	7.411	***
OC1 <--- Organizational Commitment	0.498			

Since all model fit criteria was met, the next step was to validate the Organizational Commitment measurement model. Cronbach’s alpha was calculated to measure internal consistency of the model. *IBM SPSS Reliability Analysis* calculated a Cronbach’s alpha of 0.871. The Cronbach’s alpha exceeds the recommended 0.7, indicating that the Organizational Commitment measurement model had internal consistency and was a reliable measurement construct.

4.3.1.3 Value of System Engineering

The Value of Systems Engineering consists of two factors: experience and value of SE. The first factors is experience and made up of the following three indicators corresponding do demographic questions of the survey: Systems Engineer, Career Level, and Number of projects. The second factor of the Value of SE each made up of three indicators (VSE1 through VSE3) that correspond to three survey instrument statements. As previously stated, the survey instrument used a 5-point Likert scale ranging from “Strongly Agree” to “Strongly Disagree” for non-demographic questions. The Value of Systems Engineering measurement model was validated by completing a CFA.

The first step of the CFA was to specify the model. The initial model that was specified can be seen in Figure 4.3-4. The next step was to determine if the model was identified. A CFA was completed on the proposed model, and the *IBM SPSS Amos 25* was able to determine a unique set of parameter estimates. The parameter estimates can be found in Table 4.3-3. Next model fit was evaluated using the criteria outlined in Section 3.8.2.3.5. The model fit indices for Value of SE were: $\frac{\chi^2}{df} = 9.206$, TLI = 0.495, CFI = 0.697, RMSEA = 0.202. None of the model fit criteria was satisfied which showed that the model does not fit the data well, and the initial model needed to be revised.

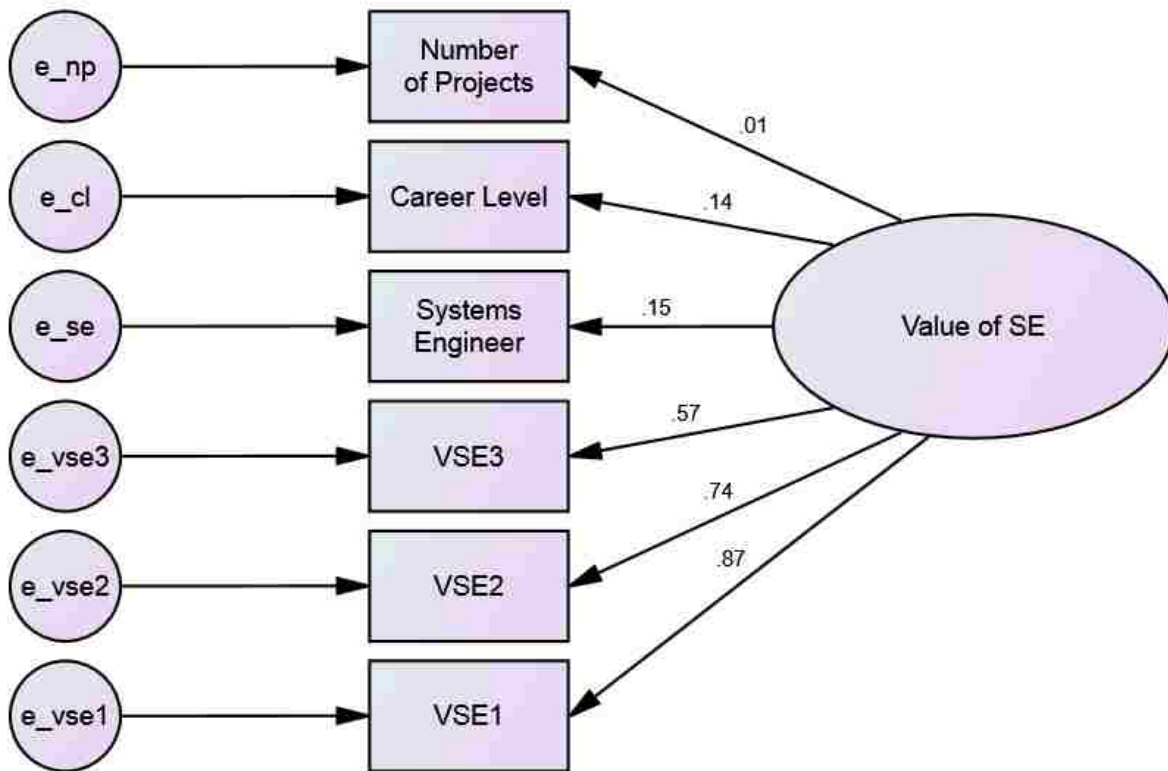

Figure 4.3-4: Initial Value of SE Measurement Model

The first step in revising the model was to evaluate the significance in the factor loading. There were two indicators (Number of Projects and Career Level) that failed to meet the statistically significant critical value criteria of greater than 1.96. Based on the factor loading criteria, Career Level and Number

of Projects are candidates for removal. Next, the modification indices were evaluated to identify what modifications can be made. The modification index showed a value above 10 for the covariance path between e_{cl} and e_{np} . Next, the Residual Covariance Matrix was evaluated and there was a large (greater than 2.58) residual covariance between Career Level and Number of Projects, which suggest that it was not adequately accounted for in the model. Both Number of Projects and Career Level were removed from the model. The revised model is illustrated in Figure 4.3-5.

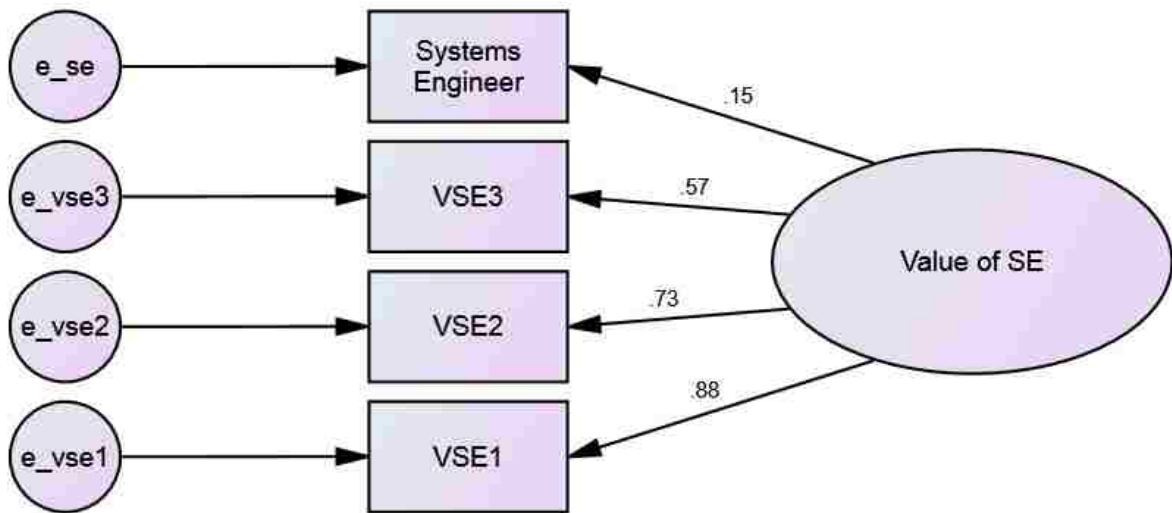

Figure 4.3-5: 1st Revised Value of SE Measurement Model

Table 4.3-3: Value of SE Measurement Model Parameter Estimates

Indicator	Initial Model				1 st Revised Model				2 nd Revised Model			
	Std. Estimate	S.E.	C.R.	P	Std. Estimate	S.E.	C.R.	P	Std. Estimate	S.E.	C.R.	P
VSE1 <--- Value of SE	0.871				0.883				0.872			
VSE2 <--- Value of SE	0.765	0.0917	983	***	0.727	0.0917	786	***	0.734	0.0918	004	***
VSE3 <--- Value of SE	0.571	0.0826	948	***	0.566	0.0836	750	***	0.571	0.0826	944	***
Systems Engineer <--- Value of SE	0.153	0.0501	9490	051	0.152	0.0501	9330	053	0.153	0.0501	9490	051
Career Level <--- Value of SE	0.136	0.1571	7020	089	Deleted				0.134	0.1551	6980	090
Number of Projects <--- Value of SE	0.015	0.1610	1880	851	Deleted				Deleted			

A CFA was conducted on the first revised Value of SE measurement model. The model estimates can be found in Table 4.3-3. All factor loadings except for Systems Engineer had a factor loading that was statistically significant, however the critical value of Systems Engineer was very close to the critical value cutoff (1.96). The revised model had the following model fit index values: $\frac{\chi^2}{df} = 2.968$, TLI = 0.978, CFI = 0.977, RMSEA = 0.099. Chi-square, TLI, and CFI all satisfied model fit criteria. However, RMSEA was between 0.08 and 0.10 model fit which suggests a mediocre fit of the model to the data. Since RMSEA was only showing a mediocre fit, this suggests that there is a degree of model misspecification. To improve misspecification, an indicator that was previously deleted was added back in. Career level was added back to the revised model. The second revised model can be found in Figure 4.3-6.

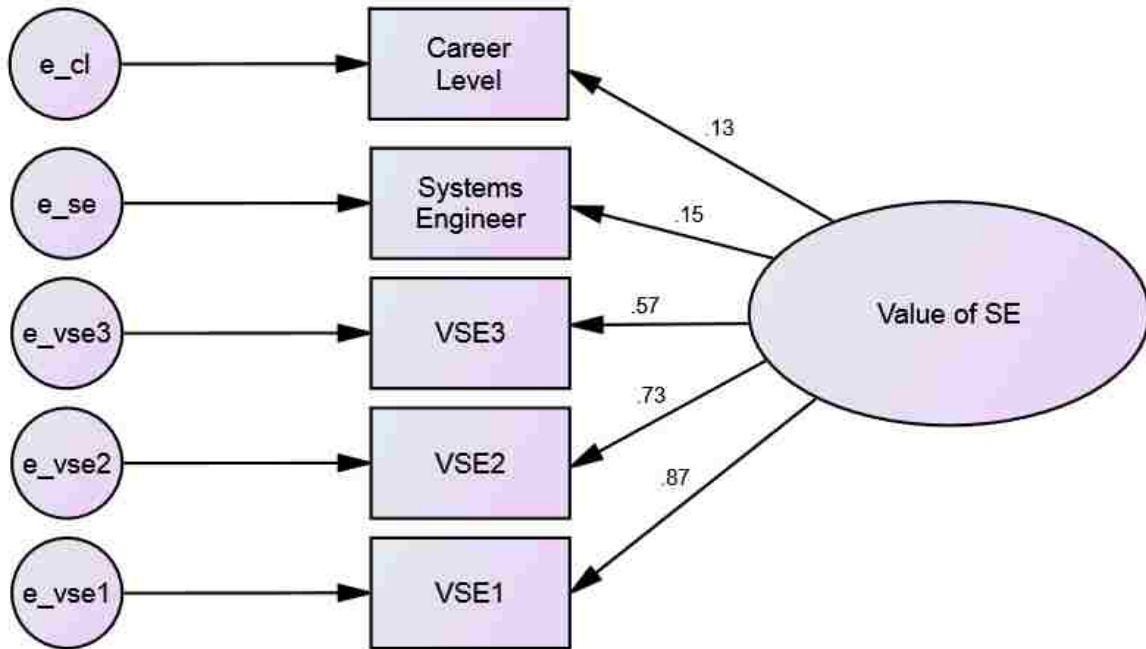

Figure 4.3-6: 2nd Revise Value of SE Measurement Model

A CFA was conducted on the second revised Value of SE measurement model. The model estimates can be found in Table 4.3-3. As expected in the second revised model, only VSE1, VSE2, and VSE3 had factor loadings that were fair or better as well as critical values that were greater than 1.96. However, Career Level and Systems Engineer had to be retained in the model to improve model fit. There were no modifications suggested by the model fit indices. Also, there were no values in the Residual Covariance Matrix of the second revised model greater than 2.58 which suggest that everything is adequately accounted for. The revised model had the following model fit index values: $\frac{\chi^2}{df} = 1.613$, TLI = 0.965, CFI = 0.982, RMSEA = 0.055. All model fit indices satisfied the model fit criteria showing a good fit for the revised measurement model. There was a sufficient model fit improvement of the second revised model compared to the initial model.

Since there was adequate model fit with the 2nd revised model, the final step was to calculate Cronbach's alpha. Cronbach's alpha was calculated using *IBM SPSS Reliability Analysis*. Cronbach's

alpha for the 2nd revised Value of SE model was 0.518. The 0.518 is below the recommended value of 0.7 indicating that there was not good internal consistency and measurement construct was not reliability. This exogenous variable was considered for removal from the overall model moving forward.

4.3.1.4 Communication

Communication consists of five indicators (Comm1 through Comm5). Each indicator correspond to a survey instrument statements. As previously stated, the survey instrument used a 5-point Likert scale ranging from “Strongly Agree” to “Strongly Disagree”. The Communication measurement model was validated by completing a CFA. The first CFA step was to specify the model. Specified model can be observed in Figure 4.3-7. The next step was to determine if the model was identified. A CFA was ran on the proposed model, and the *IBM SPSS Amos 25* was able to determine a unique set of parameter estimates. The parameter estimates can be found in Table 4.3-4. Next model fit was evaluated using the criteria outlined in Section 3.8.2.3.5. The model fit indices for Communication were: $\frac{\chi^2}{df} = 9.445$, TLI = 0.675, CFI = 0.838, RMSEA = 0.204. None of the model fit criteria was satisfied which suggested that the model needed to be revised.

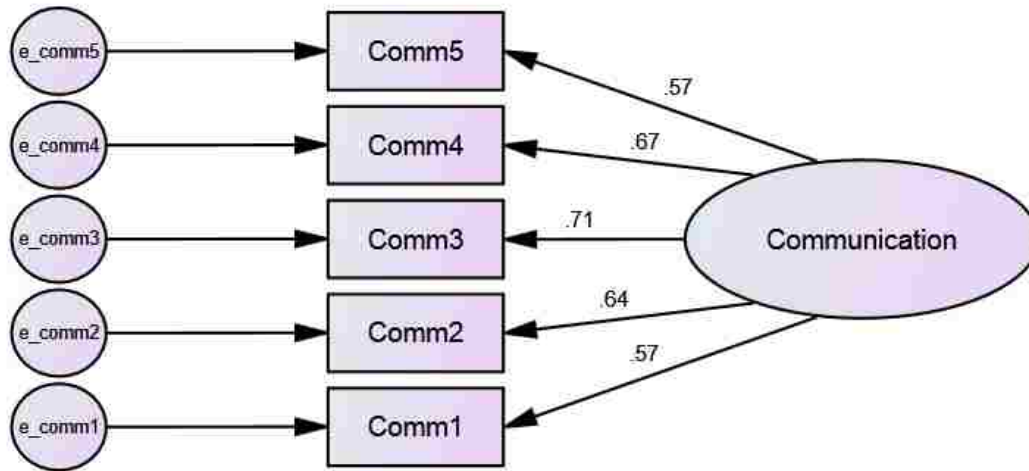

Figure 4.3-7: Initial Communication Measurement Model

Table 4.3-4: Communication Model Parameter Estimates

Indicator	Initial Model				Revised Model			
	Std. Estimate	S.E.	C.R.	P	Std. Estimate	S.E.	C.R.	P
Comm1 <--- Communication	.575				0.448			
Comm2 <--- Communication	.637	0.150	6.355	***	0.514	0.155	6.363	***
Comm3 <--- Communication	.710	0.169	6.713	***	0.789	0.312	5.167	***
Comm4 <--- Communication	.668	0.184	6.522	***	0.705	0.314	5.168	***
Comm5 <--- Communication	.565	0.167	5.892	***	0.517	0.259	4.468	***

The first step in revising the model was to evaluate the significance in the factor loading. All Communication indicators were statistically significant and had factor loading critical value magnitudes greater than 1.96. Based on the factor loading criteria identified in Table 3.8-3, all factor loadings were good or better. So there were no indicators suggested for removal based on factor loading. Next, the modification indices were evaluated to identify what modifications can be made. The modification index showed a value above 10 for two covariance paths between e_comm1-e_comm2 (30.902) and e_comm3-

e_comm4 (10.054). Next, the Residual Covariance Matrix was evaluated and there was a residual covariance the criteria of 2.58 between Comm1 and Comm2 (2.890), which suggest that it was not adequately accounted for in the model. Only the e_comm1 and e_comm2 covariance path was added to the model since the e_comm3 and e_comm4 path was not statistically significant. The revised Communication model is illustrated in Figure 4.3-8.

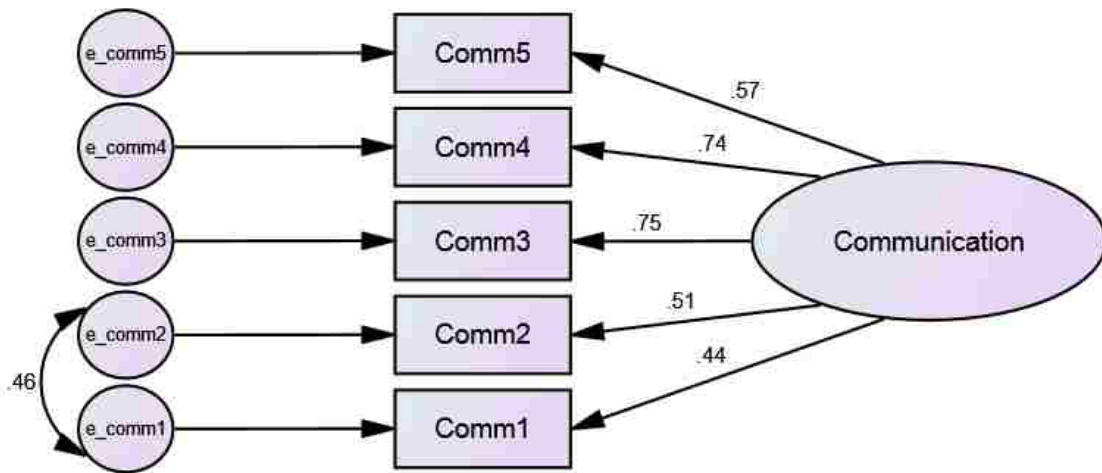

Figure 4.3-8: Revised Communication Measurement Model

A CFA was completed on the revised Communication measurement model. The model estimates can be found in Table 4.3-4. In the revised model, all factor loading estimates range from fair to excellent. Each factor loading estimate is statistically significant. The revised model had the following model fit index values: $\frac{\chi^2}{df} = 2.089$, TLI = 0.958, CFI = 0.983, RMSEA = 0.073. All model fit criteria was satisfied. The revised model was considered an adequate fit.

The final step in evaluating the revised model for Communication measurement model was to calculate Cronbach's alpha. Cronbach's alpha was calculated using *IBM SPSS Reliability Analysis*. Cronbach's alpha for the revised Communication measurement model was 0.764. The 0.764 exceeded

the recommended value of 0.7 indicating that there was good internal consistency and that the Communication measurement construct was reliable.

4.3.1.5 Systems Engineering Culture Model

As previously stated, Systems Engineering Culture (SEC) consisted of the following factors: Top Management Support, Organizational Commitment, Value of Systems Engineering, and Communication. In addition to the four factors mentioned there, demographics also play a part in Systems Engineering Culture. The demographics of: organization size and type of organization are also factors that correspond to individual survey instrument statements. A CFA was completed on Systems Engineering Culture to validate the measurement model.

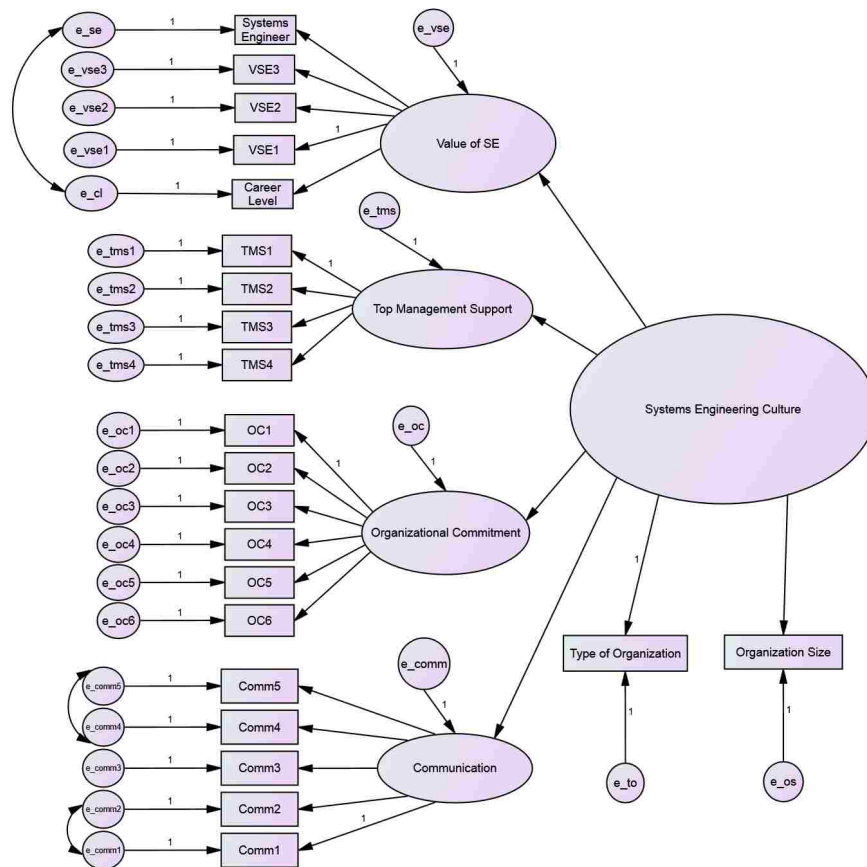

Figure 4.3-9: Initial Systems Engineering Culture Measurement Model

The first step to performing the CFA was to specify the model. The specified SEC measurement model is illustrated in Figure 4.3-9. Next step was to identify the model. A CFA was ran on the initially proposed SEC model, and the *IBM SPSS Amos 25* was able to determine a unique set of parameter estimates. The parameter estimates can be found in Table 4.3-5. Next, the model fit was evaluated using the criteria outlined in Section 3.8.2.3.5. The SEC model fit indices were compared to the criteria, and as illustrated in Table 4.3-6, TLI and CFI failed to meet the criteria. The SEC model needed to be revised in order to improve the model fit.

The first step in model revision is to evaluate the significance of each factor loading. Value of SE and Type of Org were the only two factors that failed to meet a critical value of 1.96 or greater. Both Value of SE and Type of Org were considered for removal. In addition, the standardize factor loading of Communication was greater than 1. Research completed by Deegan (1978) and Joreskog (1999) suggests that a standardize factor loading greater than one are either due to multicollinearity or are legitimate coefficient values. The correlation matrix of all of the observed variables of the SE Culture model in Appendix C was revisited, and none of the bivariate correlations exceeded the criteria established in Section 4.2.2 of a correlation not to exceed 0.90. The bivariate correlation of TMS1-TMS2 (0.870) was the only bivariate pair that was close to the criteria.

Next, the modification index was reviewed. With Value of SE being removed, modification indices showed significant cross loading with OC3, therefore it was deleted from the model. The modification indices offered no insight in to the standardize factor loading of Communication was greater than 1. Byrne (2016) suggests that in CFA cases where the standardize factor loading is greater than one, the factor can be deleted and the indicators of the deleted factor can be distributed to the construct that the factor was highly correlated with. This approach was implemented to address Communication's excessive factor loading, and the indicators were loaded directly on to SEC. The revised model is illustrated by Figure 4.3-10.

Table 4.3-5: System Engineering Culture Parameter Estimates

Paths			Initial Model				Revised Model			
			Estimate	S.E.	C.R.	P	Estimate	S.E.	C.R.	P
Value of SE	<---	SEC	0.046	0.160	0.540	0.589	deleted			
Communication	<---	SEC	1.103				deleted			
Top Mgmt. Support	<---	SEC	0.589	0.324	4.043	***	0.617	0.297	5.075	***
Org. Commitment	<---	SEC	0.564	0.101	3.712	***	0.575	0.097	4.286	***
VSE1	<---	Value of SE	0.866				deleted			
VSE2	<---	Value of SE	0.738	0.091	8.041	***	deleted			
VSE3	<---	Value of SE	0.574	0.083	6.989	***	deleted			
Systems Engineer	<---	Value of SE	0.154	0.051	1.963	0.050	deleted			
Career Level	<---	Value of SE	0.137	0.156	1.722	0.085	deleted			
TMS4	<---	Top Mgmt. Support	0.500	0.077	7.642	***	0.500	0.077	7.638	***
TMS3	<---	Top Mgmt. Support	0.775	0.056	14.837	***	0.775	0.056	14.832	***
TMS2	<---	Top Mgmt. Support	0.922	0.046	21.999	***	0.922	0.046	21.978	***
TMS1	<---	Top Mgmt. Support	0.936				0.936			
Comm1	<---	Communication	0.440				0.444			
Comm2	<---	Communication	0.467	0.145	6.296	***	0.475	0.144	6.388	***
Comm3	<---	Communication	0.741	0.270	5.706	***	0.755	0.271	5.737	***
Comm4	<---	Communication	0.746	0.324	5.403	***	0.748	0.314	5.545	***
Comm5	<---	Communication	0.599	0.275	4.963	***	0.590	0.259	5.143	***
OC4	<---	Org. Commitment	0.898	0.293	7.575	***	0.902	0.295	7.529	***
OC3	<---	Org. Commitment	0.703	0.300	6.841	***	deleted			
OC2	<---	Org. Commitment	0.867	0.337	7.558	***	0.869	0.338	7.545	***
OC1	<---	Org. Commitment	0.507				0.508			
OC5	<---	Org. Commitment	0.780	0.241	7.202	***	0.789	0.243	7.213	***
OC6	<---	Org. Commitment	0.695	0.368	6.841	***	0.682	0.365	6.764	***
Type of Org	<---	SEC	0.076	0.128	0.974	0.330	deleted			
Org Size	<---	SEC	0.176	0.125	2.160	0.031	0.187	0.137	2.280	0.023

Table 4.3-6: Systems Engineering Culture Model Fit

Model Fit Index	Criteria	Initial Model	Revised Model
$\frac{\chi^2}{df}$	< 5	2.015	2.007
TLI	> 0.90	0.876	0.928
CFI	> 0.90	0.891	0.941
RMSEA	< 0.08	0.071	0.071

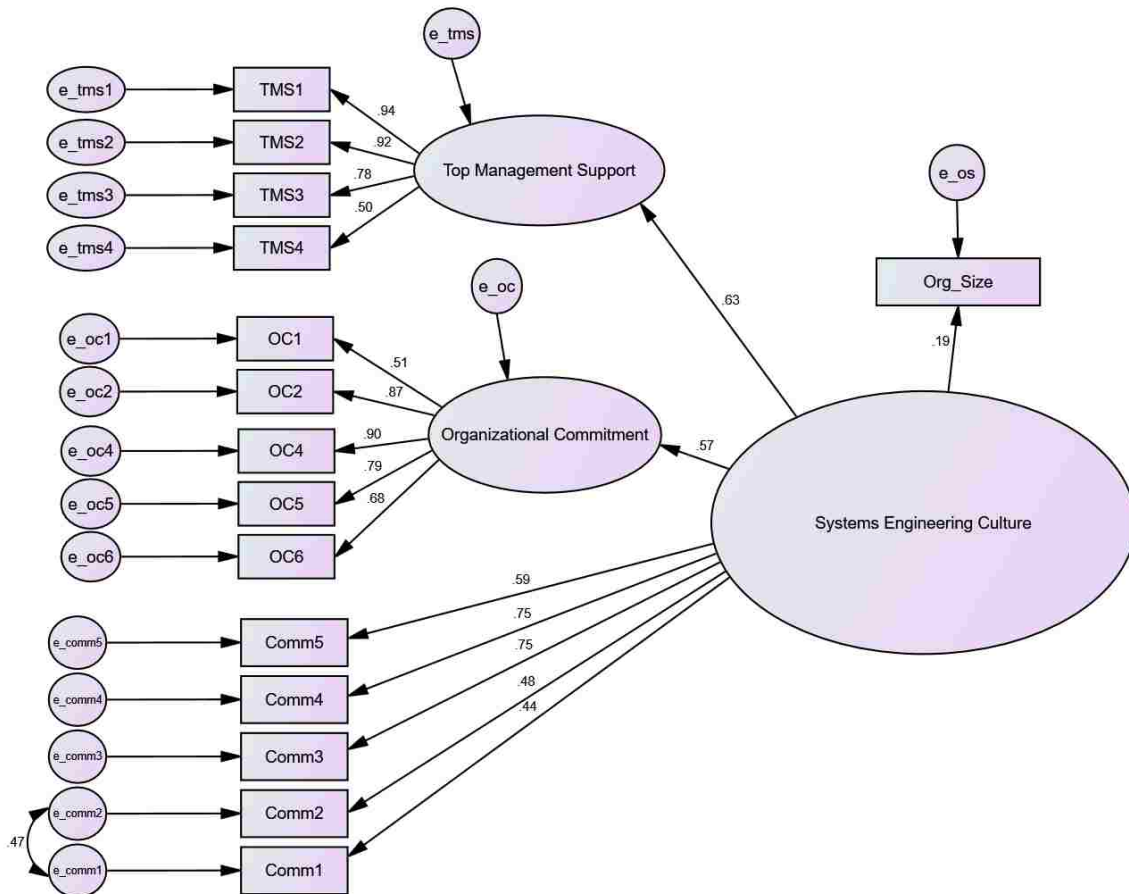

Figure 4.3-10: Revised Systems Engineering Culture Model

A CFA was completed on the revised SEC Model. *IBM SPSS Amos 25* was able to determine a unique set of parameter estimates. The parameter estimates of the revised model can be found in Table 4.3-5. The model fit indices were evaluated for the revised SEC model. As seen in Table 4.3-6, all model fit indices satisfied the criteria. This showed that the data adequately fits the model and no further revisions were required. Cronbach's alpha was calculated for the SEC measurement model using *IBM SPSS Reliability Analysis*, and Cronbach's alpha was 0.872. This values satisfied the criteria of 0.7, showing that the SEC measurement model has good internal reliability.

4.3.2 Endogenous Variables

Endogenous variables are the latent, dependent variables. The endogenous variable of this study are Systems Engineering Support (SES) and Systems Engineering Rigor (SER). The endogenous variables of this study were assessed the same way that the exogenous variables were evaluated. Systems Engineering Support was conceptualized by four latent variables: Control and Assessment, Personnel, Tools and Infrastructure, and Planning. A CFA was completed for each of the factors of Systems Engineering Support to validate the measurement model of these constructs. A measurement model was also developed for each endogenous variable and evaluated using CFA.

4.3.2.1 Control and Assessment

The Control and Assessment construct consists of four indicators (CA1 – CA4) which correspond to a survey statements. The Control and Assessment measurement model was validated by completing a CFA. The first step was to specify the model. Specified model can be observed in Figure 4.3-11. The next step was to determine if the model was identified. A CFA was ran on the initially proposed model, and the *IBM SPSS Amos 25* was able to determine a unique set of parameter estimates. The parameter estimates can be found in Table 4.3-7. Next model fit was evaluated using the criteria outlined in Section 3.8.2.3.5. The model fit indices for Control and Assessment were: $\frac{\chi^2}{df} = 0.605$, TLI = 1, CFI = 1,

RMSEA = 0. All of the model fit criteria was satisfied showing that the model adequately fit the data, therefore, no modification was required.

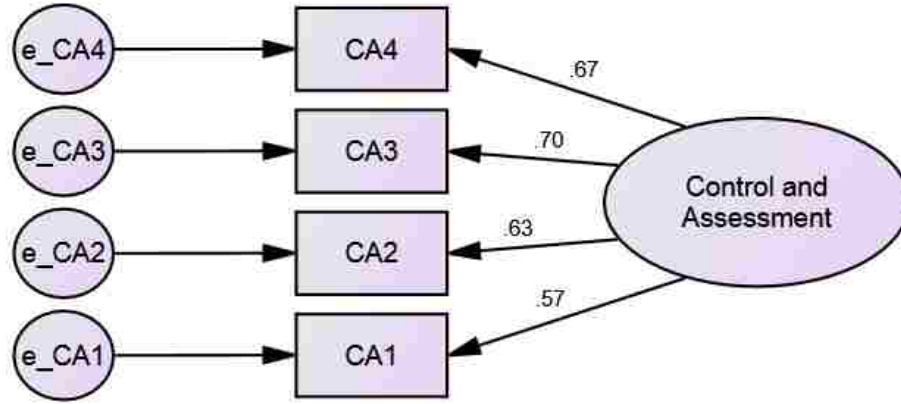

Figure 4.3-11: Control and Assessment Measurement Model

Table 4.3-7: Control and Assessment Parameter Estimates

Indicator	Standardize Estimate	S.E.	C.R.	P
CA1 <--- Control and Assessment	0.566			
CA2 <--- Control and Assessment	0.628	0.162	5.969	***
CA3 <--- Control and Assessment	0.704	0.161	6.242	***
CA4 <--- Control and Assessment	0.671	0.180	6.150	***

The final step in evaluating the model was to calculate Cronbach’s alpha. Cronbach’s alpha was calculated using *IBM SPSS Reliability Analysis*. The Cronbach’s alpha for the Control and Assessment measurement model was 0.732, which satisfies the recommended criteria of greater than 0.7. This indicated that there was good internal consistency and that the measurement construct was reliable.

4.3.2.2 Personnel

The Personnel construct consists of two factors: personnel (Per1 – Per3) and training (Trn1 – Trn3). Each indicator correspond to a survey instrument statements. The Personnel measurement model was validated by completing a CFA. The first CFA step was to specify the model. Specified model can be observed in Figure 4.3-12. The next step was to determine if the model was identified. A CFA was done on the initially proposed model, and the *IBM SPSS Amos 25* was able to determine a unique set of parameter estimates. The parameter estimates can be found in Figure 4.3-14. Next model fit was evaluated using the criteria outlined in Section 3.8.2.3.5. The model fit indices were: $\frac{\chi^2}{df} = 6.203$, TLI = 0.826, CFI = 0.895, RMSEA = 0.160. None of the model fit criteria was satisfied which indicated that the model needed to be revised.

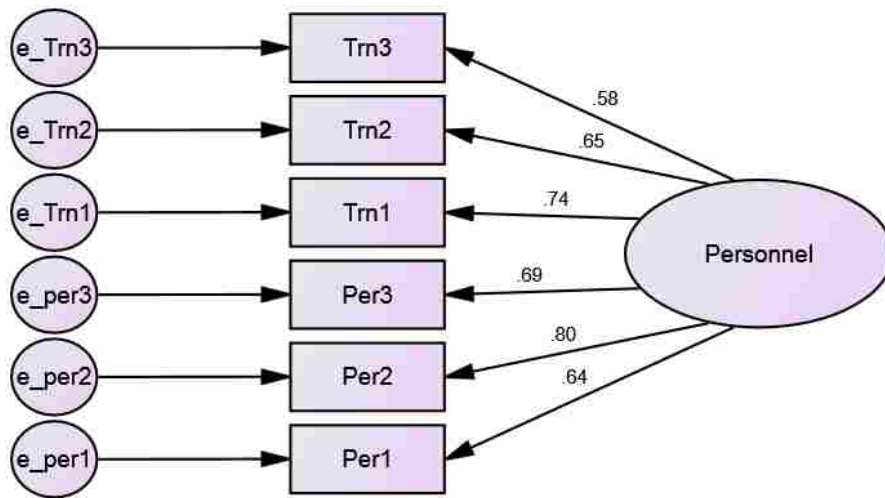

Figure 4.3-12: Initial Personnel Measurement Model

Table 4.3-8: Personnel Model Parameter Estimates

Indicator	Initial Model				Revised Model			
	Std. Estimate	S.E.	C.R.	P	Std. Estimate	S.E.	C.R.	P
Per1 <--- Personnel	0.636				0.622			
Per2 <--- Personnel	0.800	0.134	8.821	***	0.850	0.145	8.809	***
Per3 <--- Personnel	0.687	0.143	7.943	***	0.685	0.147	7.918	***
Trn1 <--- Personnel	0.737	0.118	8.367	***	0.738	0.121	8.354	***
Trn2 <--- Personnel	0.651	0.129	7.621	***	0.641	0.139	7.105	***
Trn3 <--- Personnel	0.582	0.114	6.967	***	0.511	0.115	6.183	***

First, the significance of the factor loading was evaluated. All indicators were statistically significant. Based on the factor loading criteria identified in Table 3.8-3, all factor loadings were good or better, therefore, no indicators were suggested for removal based on factor loading. Next, the modification indices were evaluated to identify suggested modifications. The modification index showed that the covariance path between e_Trn2 and e_Trn3 had a value of 31.241, which exceeded the criteria of 10. The modification index also showed a value of 9.051 for the covariance path between e_per2 and e_Trn2 which is close to the criteria of 10. Next, the Residual Covariance Matrix showed a value greater than 2.58 between Trn2 and Trn3 (2.946), which was the only item that exceeded the criteria. Based on the modification index and the residual covariance matrix a covariance path was added between e_Trn2 and e_Trn3. Since the covariance path between e_per2 and e_Trn2 was very close to the criteria and there was a lot of degrees of freedom in the model, the covariance path between e_per2 and e_Trn2 was added to the model. The revised Personnel measurement model can be found in Figure 4.3-13.

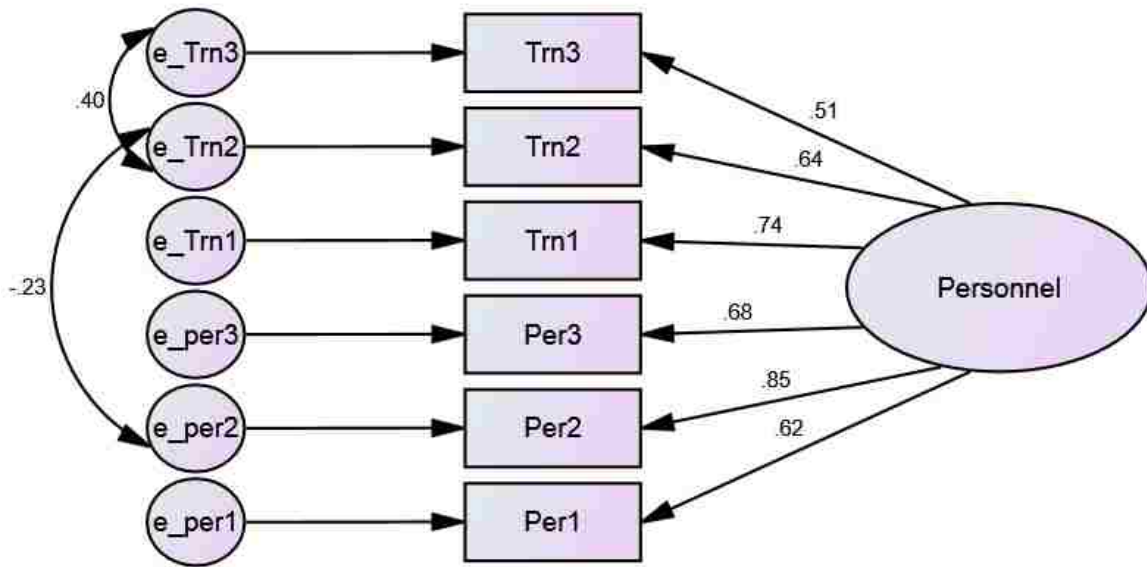

Figure 4.3-13: Revised Personnel Measurement Model

After revising the Personnel model, a CFA was completed. The model estimates can be found in Table 4.3-8. In the revised model, all factor loading estimates range from fair to excellent. Each factor loading estimate was statistically significant. The revised Personnel measurement model had the following model fit index values: $\frac{\chi^2}{df} = 2.266$, TLI = 0.958, CFI = 0.980, RMSEA = 0.079. All model fit criteria was satisfied. The revised Personnel measurement model was considered an adequate fit.

The final step in evaluating the revised model was to calculate Cronbach's alpha. Cronbach's alpha was calculated using *IBM SPSS Reliability Analysis*. The Cronbach's alpha for this measurement model was 0.839, which satisfies the recommended criteria of greater than 0.7. This indicated that there was good internal consistency and that the Personnel measurement construct was reliable.

4.3.2.3 Planning

The Planning construct consisted of four indicators (Pln1 through Pln4). Each indicator correspond to a survey instrument statements. As previously stated, the survey instrument used a 5-point

Likert scale ranging from “Strongly Agree” to “Strongly Disagree”. The Planning measurement model was validated by completing a CFA.

The first CFA step was to specify the model. Specified model can be observed in Figure 4.3-14. The next step was to determine if the model was identified. A CFA was ran on the initially proposed model, and the *IBM SPSS Amos 25* was able to determine a unique set of parameter estimates. The parameter estimates can be found in Table 4.3-9. Next model fit was evaluated using the criteria outlined in Section 3.8.2.3.5. The model fit indices for Planning were: $\frac{\chi^2}{df} = 9.613$, TLI = 0.692, CFI = 0.897, RMSEA = 0.206. None of the model fit criteria were satisfied which suggested that the model needed to be revised.

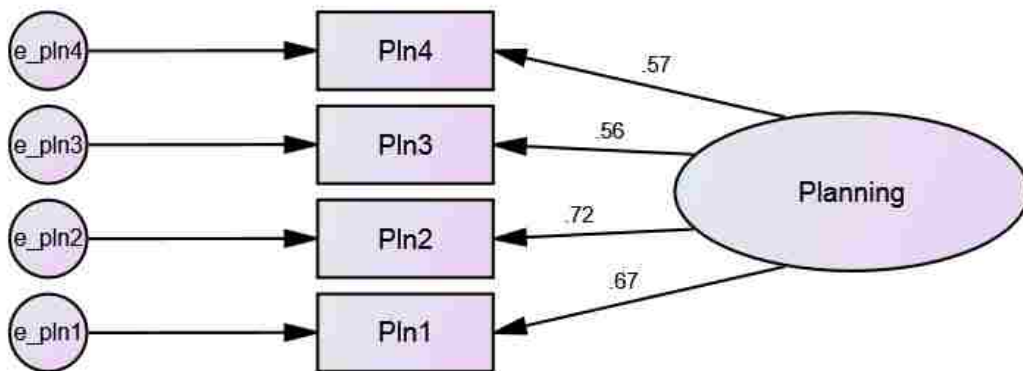

Figure 4.3-14: Initial Planning Measurement Model

Table 4.3-9: Planning Model Parameter Estimates

Indicator	Initial Model				Revised Model			
	Std. Estimate	S.E.	C.R.	P	Std. Estimate	S.E.	C.R.	P
Pln1 <--- Planning	0.673				0.830			
Pln2 <--- Planning	0.723	0.167	6.814	***	0.621	0.143	5.543	***
Pln3 <--- Planning	0.561	0.135	6.073	***	0.727	0.134	6.459	***
Pln4 <--- Planning	0.573	0.150	6.166	***	0.532	0.134	5.198	***

The significance in the factor loading was evaluated as the first step in revising the model. All Planning indicators were statistically significant. Based on the factor loading criteria identified in Table 3.8-3, all factor loadings were good or better. So there were no indicators suggested for removal based on factor loading. Next, the modification indices were evaluated to identify what modifications can be made. The modification index showed no values above 10, however there was a value of 8.553 for two covariance paths between e_pln1 and e_pln3. Next, the Residual Covariance Matrix was evaluated and there was no values that exceeded criteria of 2.58. Since none of the model fit indices satisfied the criteria, and the only significant indicator of a modification was a covariance path between e_pln1 and e_pln3, it was added to the model. The revised Planning measurement model can be found in Figure 4.3-15.

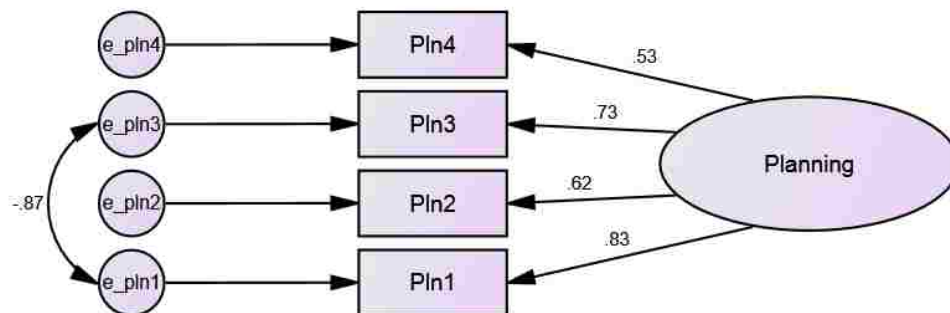

Figure 4.3-15: Revised Planning Measurement Model

After revising the Planning measurement model, a CFA was completed. The model estimates can be found in Table 4.3-9. In the revised model, all factor loading estimates ranged from fair to excellent. Each factor loading estimate was statistically significant. The revised Planning measurement model had the following model fit index values: $\frac{\chi^2}{df} = 0.478$, TLI = 1, CFI = 1, RMSEA = 0. All model fit criteria was satisfied. The revised Planning measurement model was considered an adequate fit.

The final step in evaluating the revised model for the Planning measurement model was to calculate Cronbach's alpha. Cronbach's alpha was calculated using *IBM SPSS Reliability Analysis*. The Cronbach's alpha for this measurement model was 0.726, which satisfies the recommended criteria of greater than 0.7. This indicates that there is good internal consistency and that the Planning measurement construct is reliable.

4.3.2.4 Tools and Infrastructure

The Tools and Infrastructure consists of four indicators (TI1 – TI4) which correspond to a survey instrument statements. The Personnel measurement model was validated by completing a CFA. The first CFA step was to specify the model. Specified model can be observed in Figure 4.3-16. The next step was to determine if the model was identified. A CFA was ran on the initially proposed model, and the *IBM SPSS Amos 25* was able to determine a unique set of parameter estimates. The parameter estimates can be found in Table 4.3-10. Next model fit was evaluated using the criteria outlined in Section

3.8.2.3.5. The model fit indices for Tools and Infrastructure were: $\frac{\chi^2}{df} = 1.037$, TLI = 0.999, CFI = 1,

RMSEA = 0.014. All of the model fit criteria was satisfied showing that the model adequately fit the data, therefore, no modification was required.

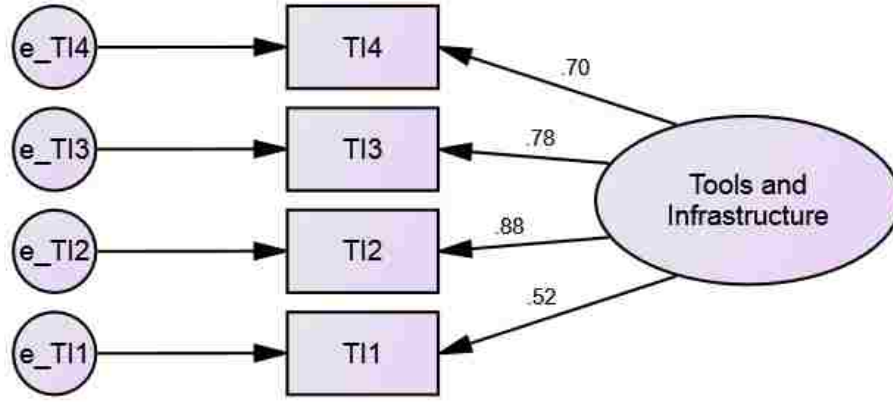

Figure 4.3-16: Tools and Infrastructure Measurement Model

Table 4.3-10: Tools and Infrastructure Model Parameter Estimates

Indicator	Standardize Estimate	S.E.	C.R.	P
T11 <--- Tools and Infrastructure	0.521			
T12 <--- Tools and Infrastructure	0.882	0.194	7.259	***
T13 <--- Tools and Infrastructure	0.776	0.182	7.072	***
T14 <--- Tools and Infrastructure	0.698	0.176	6.725	***

The final step in evaluating the model was to calculate Cronbach’s alpha. Cronbach’s alpha was calculated using *IBM SPSS Reliability Analysis*. The Cronbach’s alpha for the Tools and Infrastructure measurement model was 0.802, which satisfies the recommended criteria of greater than 0.7. This indicates that there was good internal consistency and that the measurement construct was reliable.

4.3.2.5 Systems Engineering Support Model

Systems Engineering Support (SES) consists of four factors: Planning, Personnel, Tools & Infrastructure, and Control and Assessment. As previously stated, each factor corresponded to four or more separate survey statements. Individual measurement models were evaluated for each of the four factors of SES. A measurement model for SES was developed based on each of the four factors. A CFA was completed on the SES measurement model to validate the model.

The first step, the SES model was specified. The specified SES model is illustrated in Figure 4.3-17. A CFA was done on the initial SES model. *IBM SPSS Amos 25* was able to determine a unique set of parameter estimates. The initial SES model parameter estimates can be found in Table 4.3-11. Next the model fit indices of the initial model were evaluated. The model fit index values can be found in Table 4.3-12. All of the model fit indices violated the model fit criteria, which required the model to be revised to improve model fit.

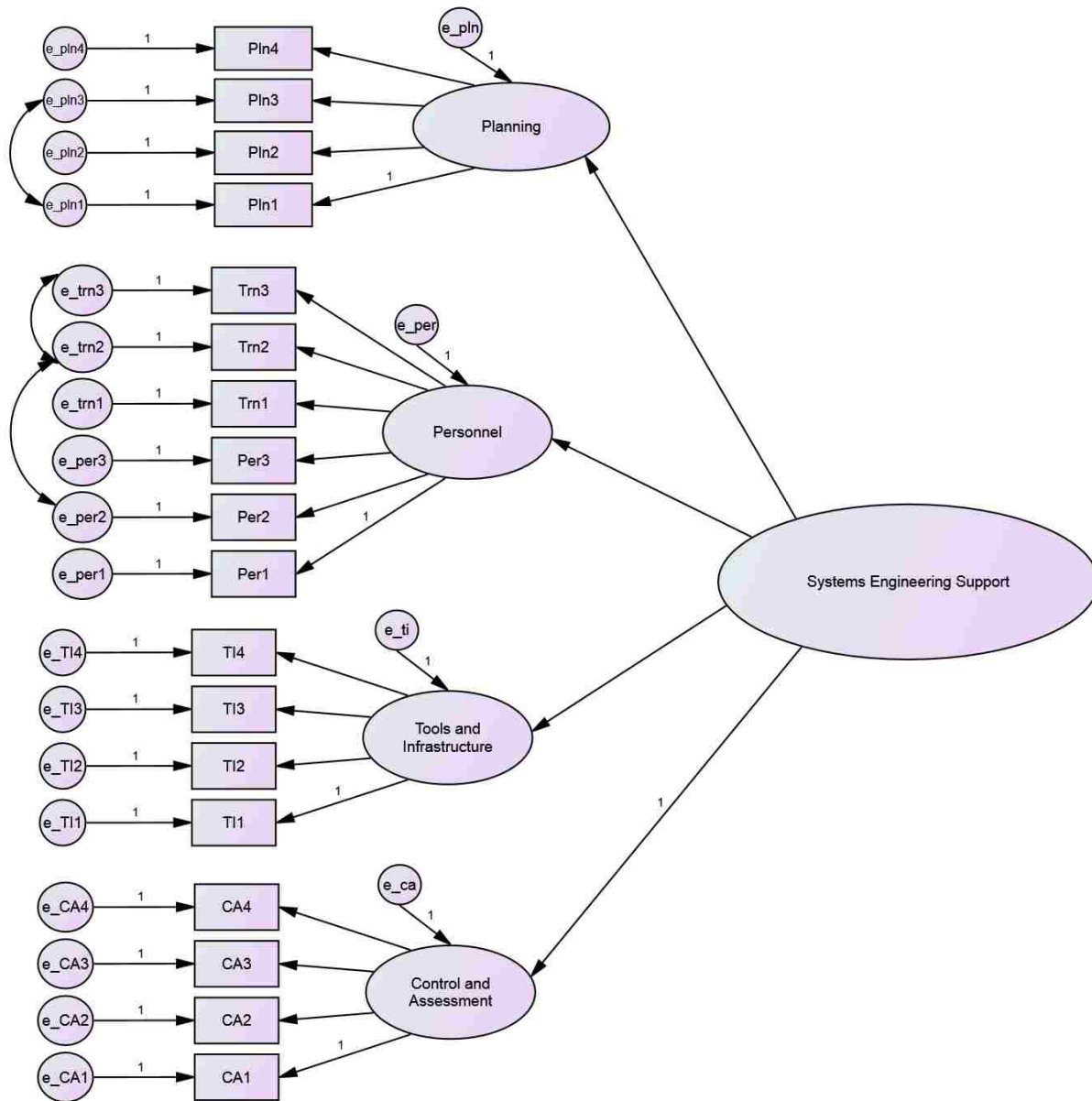

Figure 4.3-17: Systems Engineering Support Measurement Model

Table 4.3-11: Systems Engineering Support Parameter Estimates

Path			Initial Model				Revised Model			
			Estimate	S.E.	C.R.	P	Estimate	S.E.	C.R.	P
Planning	<---	SES	0.835	0.122	6.765	***	0.709	0.116	6.882	***
Personnel	<---	SES	0.975	0.147	6.775	***	0.962	0.136	6.676	***
Tools & Infrastructure	<---	SES	0.847	0.129	6.060	***	0.902	0.134	6.251	***
Control & Assessment	<---	SES	0.904				0.964			
CA1	<---	Control & Assessment	0.631				0.614			
CA2	<---	Control & Assessment	0.667	0.120	7.637	***	0.680	0.129	7.659	***
CA3	<---	Control & Assessment	0.653	0.112	7.518	***	0.607	0.113	7.073	***
CA4	<---	Control & Assessment	0.615	0.127	7.172	***	deleted			
TI1	<---	Tools & Infrastructure	0.545				0.554			
TI2	<---	Tools & Infrastructure	0.867	0.166	7.958	***	0.837	0.158	7.840	***
TI3	<---	Tools & Infrastructure	0.770	0.161	7.552	***	deleted			
TI4	<---	Tools & Infrastructure	0.711	0.159	7.233	***	0.725	0.159	7.285	***
Pln1	<---	Planning	0.674				0.778			
Pln2	<---	Planning	0.680	0.137	7.790	***	0.128	7.956	***	***
Pln3	<---	Planning	0.771	0.156	7.244	***	0.887	0.145	7.276	***
Pln4	<---	Planning	0.522	0.132	6.361	***	0.484	0.138	4.882	***
Per1	<---	Personnel	0.601				0.596			
Per2	<---	Personnel	0.790	0.142	8.655	***	0.803	0.150	8.572	***
Per3	<---	Personnel	0.680	0.153	7.829	***	0.681	0.159	7.664	***
Trn1	<---	Personnel	0.783	0.128	8.629	***	0.785	0.135	8.478	***
Trn2	<---	Personnel	0.641	0.138	7.429	***	deleted			
Trn3	<---	Personnel	0.577	0.120	6.897	***	deleted			

Table 4.3-12: SES Model Fit Indices

Model Fit Index	Criteria	Initial Model	Revised Model
$\frac{\chi^2}{df}$	< 5	2.873	2.020
TLI	> 0.90	0.832	0.919
CFI	> 0.90	0.859	0.937
RMSEA	< 0.08	0.096	0.071

Table 4.3-13: SES Modification Indices

Covariance	M.I.	Par Change	Regression Weights	M.I.	Par Change
e_pln1 <--> e_trn2	11.632	0.118	Trn2 <--- Pln1	10.806	0.188
e_TI3 <--> e_trn3	16.088	0.114	Pln3 <--- CA4	13.415	0.168
e_TI3 <--> e_per1	19.299	-0.155	Pln2 <--- Trn3	10.852	0.190
e_CA4 <--> e_pln3	16.879	0.146	TI3 <--- Per1	13.092	-0.154
e_CA4 <--> e_pln1	10.219	-0.126	CA4 <--- Pln3	11.150	0.220
e_CA2 <--> e_ti	10.328	-0.065	CA4 <--- Pln1	12.258	-0.228

The first step in model revision is to evaluate the statistical significance of each factor loading. All factor loadings satisfied the greater than 1.96 critical value criteria. Next, the modification indices in Table 4.3-13 were evaluated. There were several error correlation and cross-factor loading that exceeded 10. CA4, TI3, and Trn2 were deleted to remove any error covariance. Based on the variables that were removed, only the covariance between e_CA2 and e_ti needed to be added to the model. Next, the Standardize Residual Covariance Matrix was examined. Trn3 was the only covariance that exceeded the Standardize Residual Covariance criteria value of 2.58 that was not accounted for by the modification index. The revised SES model is illustrated in Figure 4.3-18.

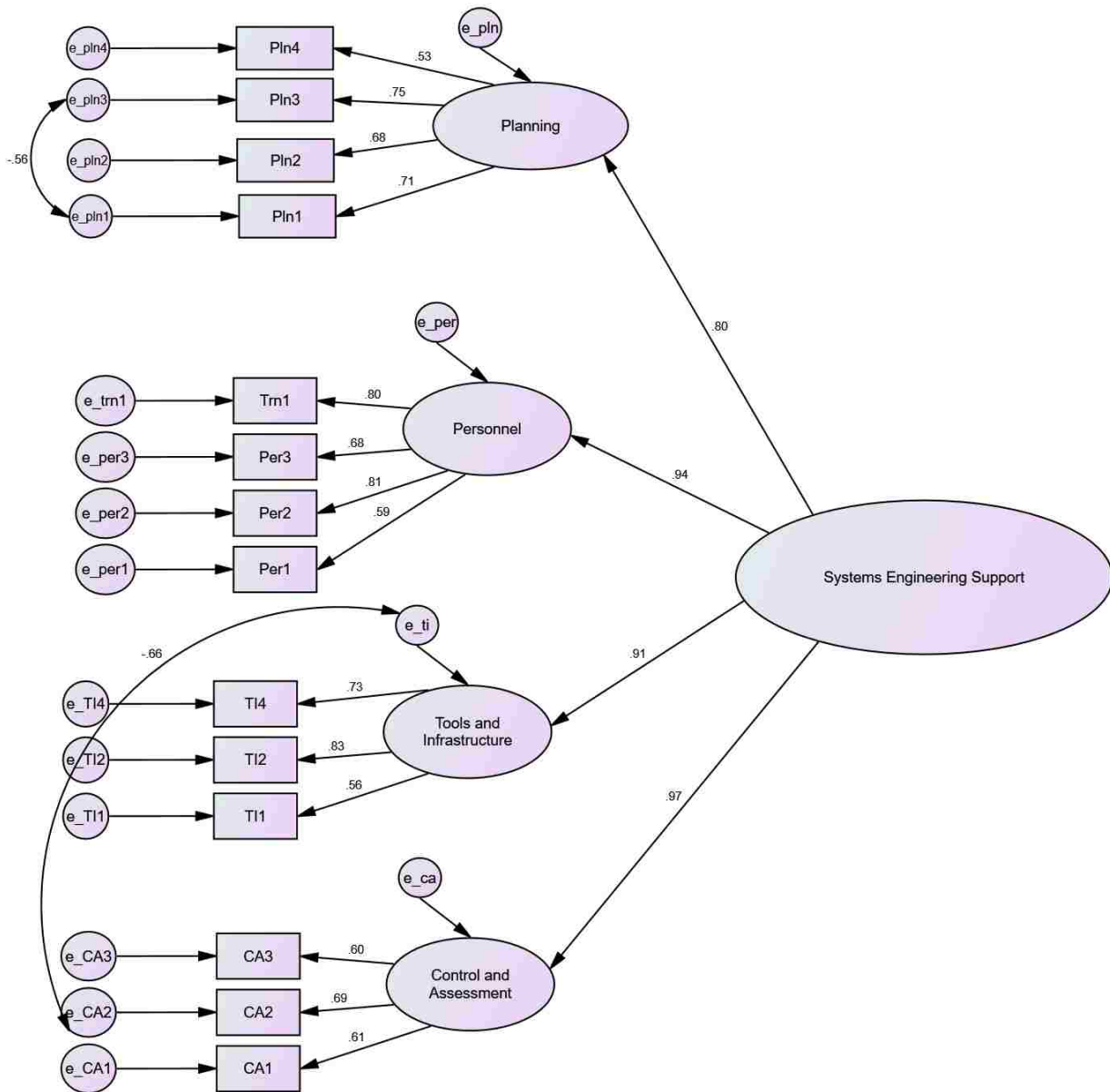

Figure 4.3-18: Revised Systems Engineering Support Measurement Model

A CFA was completed on the revised SES measurement model. The model estimates of the revised model can be found in Table 4.3-11. All factor loadings of the revised SES model remained statistically significant. The model fit indices for the revised model can be found in Table 4.3-12. All model fit indices satisfied the model fit index criterion, which demonstrated that the data adequately fitted

the revised SES model. Cronbach's alpha for the SES model was calculated using *IBM SPSS Reliability Analysis*. Cronbach's alpha was determined to be 0.898, which satisfied the criteria of greater than 0.7. A Cronbach's alpha of 0.898 shows that there was good internal reliability with the SES model.

4.3.2.6 Systems Engineering Rigor

SER is made up of the following three factors: manufacturing issues (MI1 and MI2), integration and test issues (ITI1 and ITI2), and launch issues (LI1 and LI2). Each factor's indicator corresponded to a survey instrument statement. To validate the Systems Engineering Rigor measurement model, a CFA was completed. The first step to performing the CFA was to specify the SER model. The specified SER measurement model is illustrated in Figure 4.3-19. Next, the model was identified. A CFA was ran on the SER model. *IBM SPSS Amos 25* was able to determine a unique set of parameter estimates. The parameter estimates can be found in Table 4.3-14. Next, the model fit was evaluated using the criteria outlined in Section 3.8.2.3.5. The SER model fit indices and criteria can be found in Table 4.3-15. All of the model fit indices failed to satisfy the criteria. The SER model needed to be revised in order to improve the model fit.

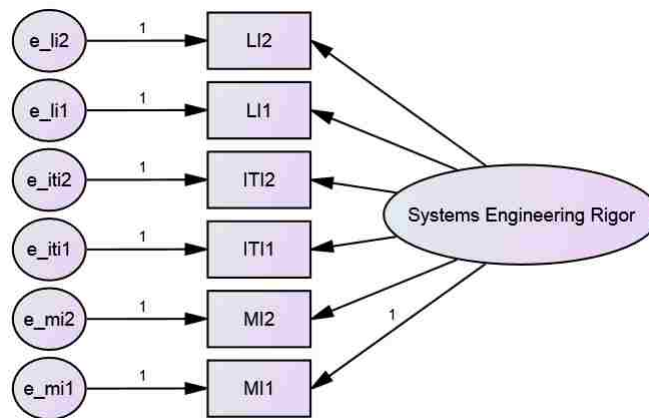

Figure 4.3-19: Systems Engineering Rigor Measurement Model

Table 4.3-14: Systems Engineering Rigor Parameter Estimates

Indicator	Initial Model				Revised Model			
	Std. Estimate	S.E.	C.R.	P	Std. Estimate	S.E.	C.R.	P
MI1 <--- SER	0.779							
MI2 <--- SER	0.834	0.073	13.249	***	0.753	0.055	19.021	***
ITI1 <--- SER	0.894	0.072	14.545	***	0.855	0.080	14.359	***
ITI2 <--- SER	0.893	0.068	14.504	***	0.941	0.075	13.759	***
LI1 <--- SER	0.904	0.066	14.754	***	0.893	0.073	13.235	***
LI2 <--- SER	0.899	0.070	14.637	***	0.870	0.078	13.162	***

Table 4.3-15: Systems Engineering Rigor Model Fit Indices

Model Fit Index	Criteria	Initial Model	Revised Model
$\frac{\chi^2}{df}$	< 5	20.667	1.083
TLI	> 0.90	0.774	0.999
CFI	> 0.90	0.864	1
RMSEA	< 0.08	0.312	0.02

The first step in revising the SER model was to evaluate the statistical significance of the factor loading. All indicators had a critical value greater than 1.96, which meant that each factor was statically significant. Comparing the factor loading to the criteria identified in Table 3.8-3, all factor loadings were excellent, therefor, none of the indicators were considered for removal based on factor loading. Next, the modification indices were evaluated to identify suggested modifications. Based on the modification index criteria of 10, the covariance paths in Table 4.3-16 exceeded the threshold and were considered for revising. The Standard Residual Covariance matrix was also examined, and there were no values that

exceeded the threshold that were not already accounted for in the modifications made to the SER measurement model. The revised SER measurement model can be found in Figure 4.3-20.

Table 4.3-16: Initial SER Model Modification Index Values Above 10

Path	M.I.
e_li1 <--> e_li2	47.818
e_it1 <--> e_li2	12.239
e_mi2 <--> e_li1	21.310
e_mi1 <--> e_li2	17.223
e_mi1 <--> e_mi2	69.403
e_mi2 <--> e_it1	11.043
e_mi2 <--> e_it1	14.866
e_mi1 <--> e_it1	12.314

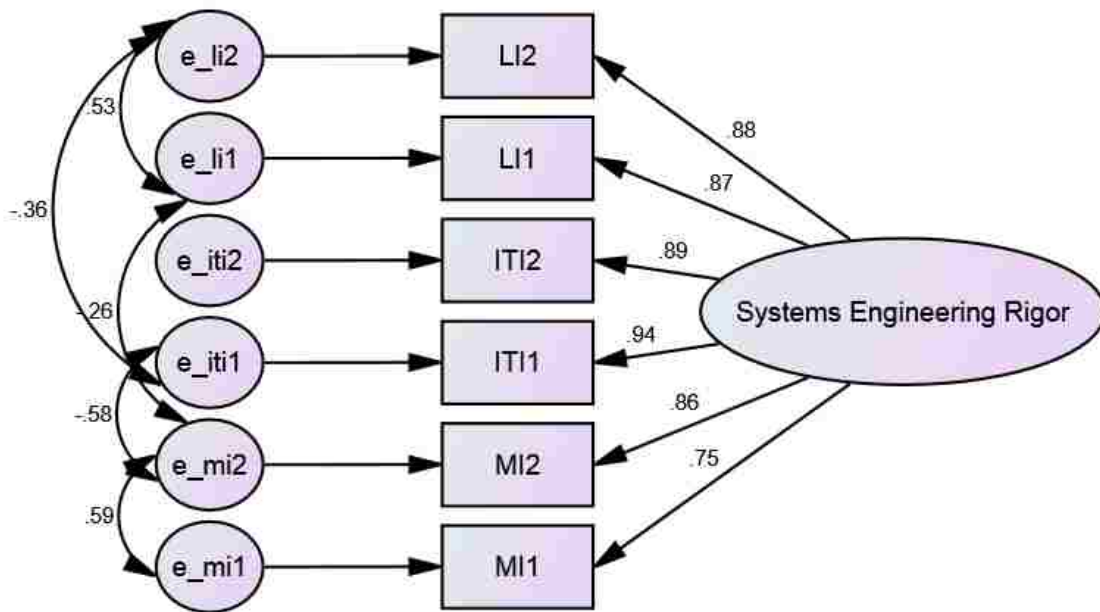

Figure 4.3-20: Revised Systems Engineering Rigor Measurement Model

A CFA was completed on the revised SER Model. As seen in Table 4.3-14 all factor loadings in the revised model were statically significant. The model fit indices were evaluated for the revised SER model, and all model fit indices satisfied the criteria. A comparison of the model fit indices against the criteria can be found in Table 4.3-15. A significant improvement in model fit of the revised model over the initial model can also be observed in the table. Satisfying the model fit criteria showed that the data was a good fit for the revised SER model.

The final step to validating the revised SER model was to calculate Cronbach's alpha. Cronbach's alpha was calculated using *IBM SPSS Reliability Analysis*. The Cronbach's alpha for the SER model was 0.947, which satisfied the recommended criteria of greater than 0.7. Satisfying the Cronbach's alpha criteria indicated that there was good internal consistency and that the SER measurement construct was reliable.

4.3.3 Hypothesized Systems Engineering Culture, Support, and Rigor Model

Prior to evaluating the model that was originally hypothesized in Section 3.4, each latent variable of the model was individually evaluated. In evaluating the measurement of each latent variable, a CFA was completed to validate the measurement model of each construct. The results of the CFA showed that each latent variable measurement model adequately fit the data. Cronbach's alpha was also performed on each of the measurement models to ensure good internal consistency. The revised measurement model of each construct achieved a satisfactory Cronbach's alpha.

4.3.3.1 Evaluating the Hypothesized Model

The measurement model of each construct was first evaluated individually to minimize complications in the evaluation of the hypothesized model. After the measurement model of each construct achieved a satisfactory model fit and was validated, the individual models were combined to form the initial structural equation model that was hypothesized in earlier chapters. The initial

hypothesized model can be found in Figure 4.3-21. A CFA was conducted on the hypothesized SE Culture-Support-Rigor model using the same process that was used to validate the individual measurement models.

The first step was to specify the model. Model specification was completed by combining each of the individual measurement models (Figure 4.3-21). Parameter estimates were calculated, and as observed in Table 4.3-18 there are strong positive correlations between all three of the latent variables. The correlations among the latent variables were statistically significant with critical ratios greater than 1.96 at $p < 0.001$. Next, the model fit was evaluated. The model fit indices for the SE Culture-Support-Rigor model and their criteria can be found in Table 4.3-19. TLI (0.884) and CFI (0.895) were just below the model fit criteria (>0.9). The model needed to be revised.

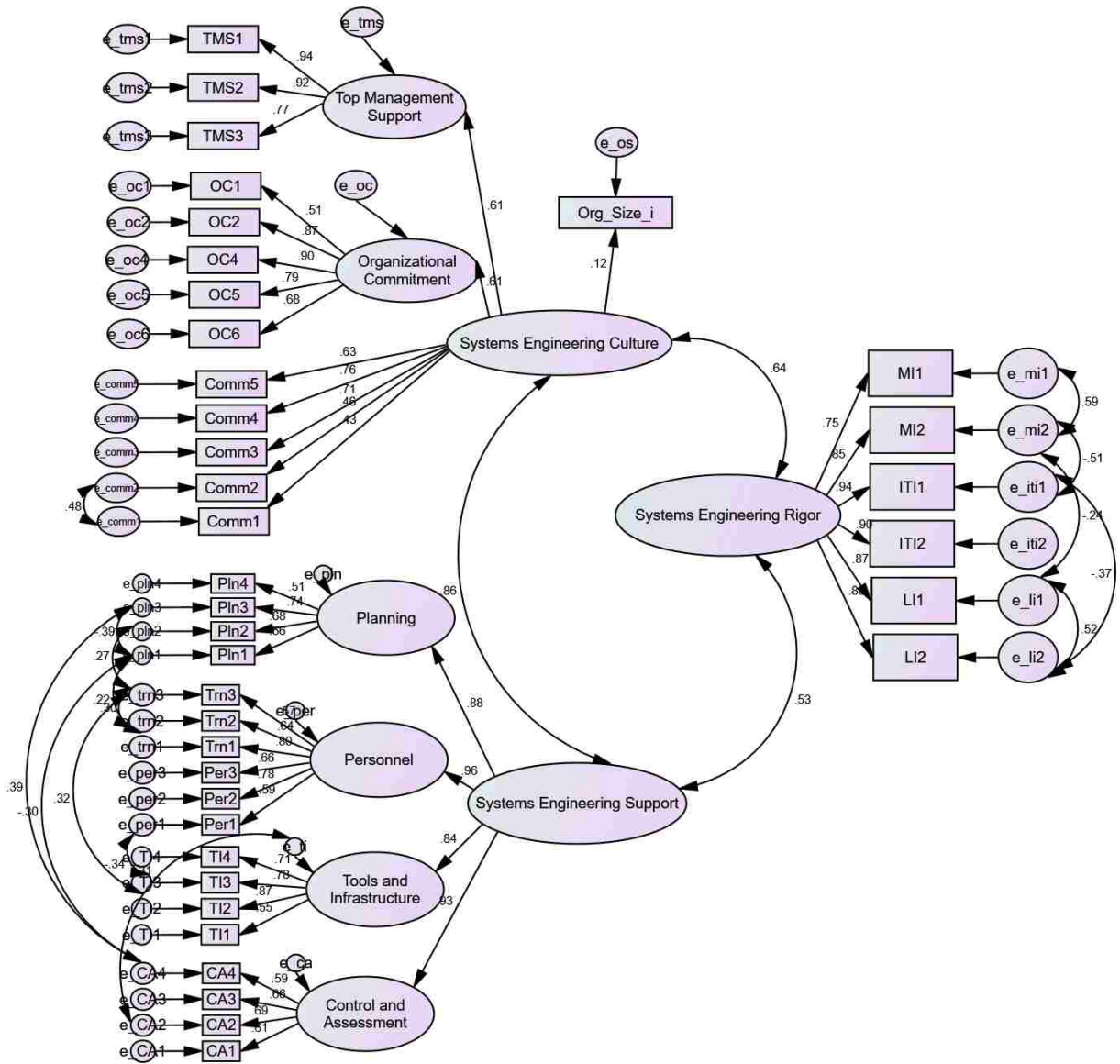

Figure 4.3-21: Initial Hypothesized Systems Engineering Culture-Support-Rigor Model

To revise the model, first, the factor loading for each parameter was evaluated. All but one factor had a loading that was statistically significant. Org Size (1.589) was the only factor that failed to achieve a critical value greater than 1.96 and was thus eliminated from the model. The correlations among the latent constructs were also examined. SEC and SES had a very high correlation (0.861). This could prove problematic in later phases of SEM. As many SEM researches have stated, a high correlation

between two latent variables suggests that the latent variables are representing the same construct. A correlation of 0.861 between SEC and SES would likely get even larger once the model is revised to improve model fit. Rather than combining the indicators of SEC and SES, leaving a SEM with only one exogenous and one endogenous variable, the decision was made to reduce the measurement model from a second order measurement model to a first order measurement model which is illustrated in Figure 4.3-22. This would allow each factor that composed the SEC and SES constructs to be evaluated individually within the model and identify where the SEC and SES constructs overlapped.

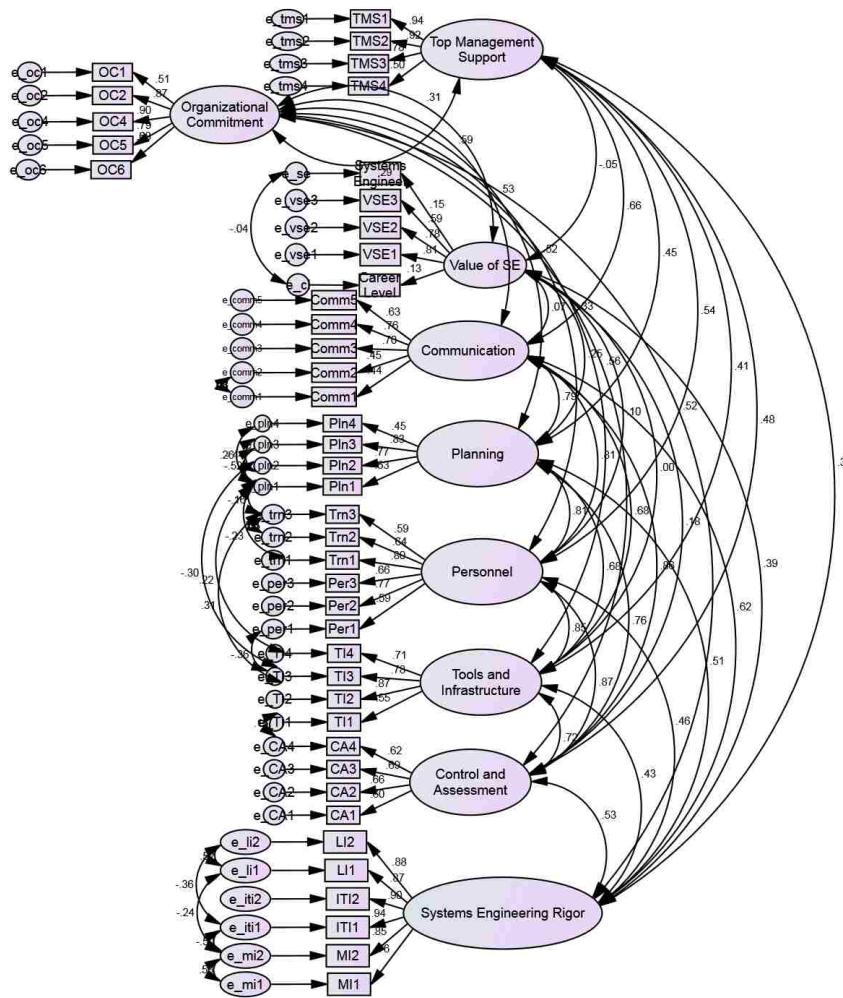

Figure 4.3-22: Revised 1st Order Hypothesized Model

A CFA was completed on the revised hypothesized model. TLI and CFI failed to satisfy the model fit criteria. The model needed to be revised. First, the factor loading for each parameter was evaluated. All but one factor had a loading that was statistically significant. Career Level (1.731) was the only factor that failed to achieve a critical value greater than 1.96 and was thus eliminated from the model.

The modifications suggested by the indices are found in Table 4.3-17. Review of the Modification Indices show that there were large error covariance and regression weight (factor loading) cross loading. TMS3 and Per3 were removed from the model due to the cross loading. TMS4 was not considered for removal to try to maintain a minimum of three indicators per factor. The indicator level error covariance paths suggested by the modification index were added to the model. The Standardized Residual Covariance Matrix was also reviewed to identify any variables that had values greater than 2.56. OC6, TMS4, and Tr3 were removed due to values exceeding 2.56 in the Standardized Residual Covariance Matrix. Removing TMS4 would reduce Top Management Support to two indicators, however, due to the numerous large residual covariance values associated with TMS4, TMS4 was grossly unaccounted for and had to be removed. Although Top Management Support would only have two indicators, research completed by Hair et al. (2014) suggest that SEM analyses are routinely completed with one indicator per factor and is acceptable as long as the indicator was carefully considered. All of the indicators of the hypothesized model were carefully considered.

Table 4.3-17: Modification Indices for Initial SE Culture-Support-Rigor Model

Covariance		M.I.	Par Change	Cross Loading		M.I.	Par Change
e_oc2	<--> e_vse2	11.203	0.06	TMS3	<--- Personnel	10.835	0.264
e_mi1	<--> Value of SE	10.274	0.068	TMS3	<--- Planning	11.206	0.283
e_trn3	<--> Planning	10.431	0.048	TMS3	<--- Trn2	10.581	0.154
e_trn3	<--> e_tms1	10.401	0.062	TMS3	<--- Trn1	11.143	0.179
e_trn2	<--> Top Mgmt. Support	13.277	0.135	TMS3	<--- TI1	15.405	0.178
e_per2	<--> e_per3	11.081	0.121	TMS3	<--- CA1	20.768	0.2
e_TI2	<--> e_oc6	10.179	0.084	TMS4	<--- C&A	11.319	0.387
e_TI2	<--> e_tms3	13.16	-0.083	TMS4	<--- CA4	13.052	0.246
e_TI1	<--> e_comm3	11.696	-0.118	TMS4	<--- CA3	10.349	0.252
e_CA4	<--> e_comm1	19.729	0.164	VSE1	<--- Comm1	12.544	-0.191
e_CA4	<--> e_pln3	14.328	0.127	Comm3	<--- TI1	11.832	-0.139
e_CA4	<--> e_pln1	15.117	-0.138	Comm1	<--- CA4	10.981	0.16
e_CA2	<--> Personnel	10.62	0.057	TMS2	<--- Trn3	10.211	-0.126
e_CA1	<--> e_tms3	14.351	0.15	MI1	<--- VSE3	12.528	0.139
				Trn2	<--- TMS3	10.067	0.159
				Trn1	<--- LI2	10.179	0.163
				Trn1	<--- ITI2	11.493	0.177
				Per3	<--- LI2	12.167	-0.266
				TI2	<--- OC6	11.566	0.122
				TI1	<--- Pln1	10.345	0.219
				CA4	<--- Comm1	13.384	0.241
				CA4	<--- Pln1	15.599	-0.249
				CA1	<--- TI1	11.517	0.206

Next, the correlations between the latent constructs were reviewed. The correlations between the latent constructs of the hypothesized model can be found in Table 4.3-18. It can be observed from the Table 4.3-18 that Personnel has a very high correlation with T&I (0.859), Planning (0.857), and C&A (0.890), which is expected since a measurement model that achieved adequate model fit was previously evaluated in Section 4.3.2.5 where SES was the latent construct being measured by Personnel, T&I, Planning and C&A. However, Communication also had a very high correlation with Personnel (0.827), Planning (0.845), and C&A (0.845). Very high correlations between these five latent variables suggest that they are representing the same latent construct. Communication appeared to be the overlap between

SEC and SES that was discovered earlier. Based on this, the model was revised to reconstitute the SES construct with Communication, Personnel, Planning, C&A, and T&I as the indicators. The revised model is illustrated in Figure 4.3-23.

Table 4.3-18: Correlations of Latent Variables of 1st Order Hypothesized Model

	SER	TMS	OC	Com	Personnel	Plan	T&I	VSE	C&A
SER	---								
TMS	0.346	---							
OC	0.510	0.262	---						
Com	0.619	0.631	0.563	---					
Personnel	0.472	0.534	0.496	0.827	---				
Planning	0.546	0.451	0.541	0.845	0.857	---			
T&I	0.449	0.371	0.338	0.707	0.859	0.733	---		
VSE	0.408	-0.048	0.295	0.088	0.081	0.259	0.025	---	
C&A	0.536	0.454	0.532	0.845	0.890	0.795	0.726	0.159	---

SER = Systems Engineering Rigor, TMS = Top Management Support, OC = Organizational Commitment, Com = Communication, T&I = Tools and Infrastructure, C&A = Controls and Assessment

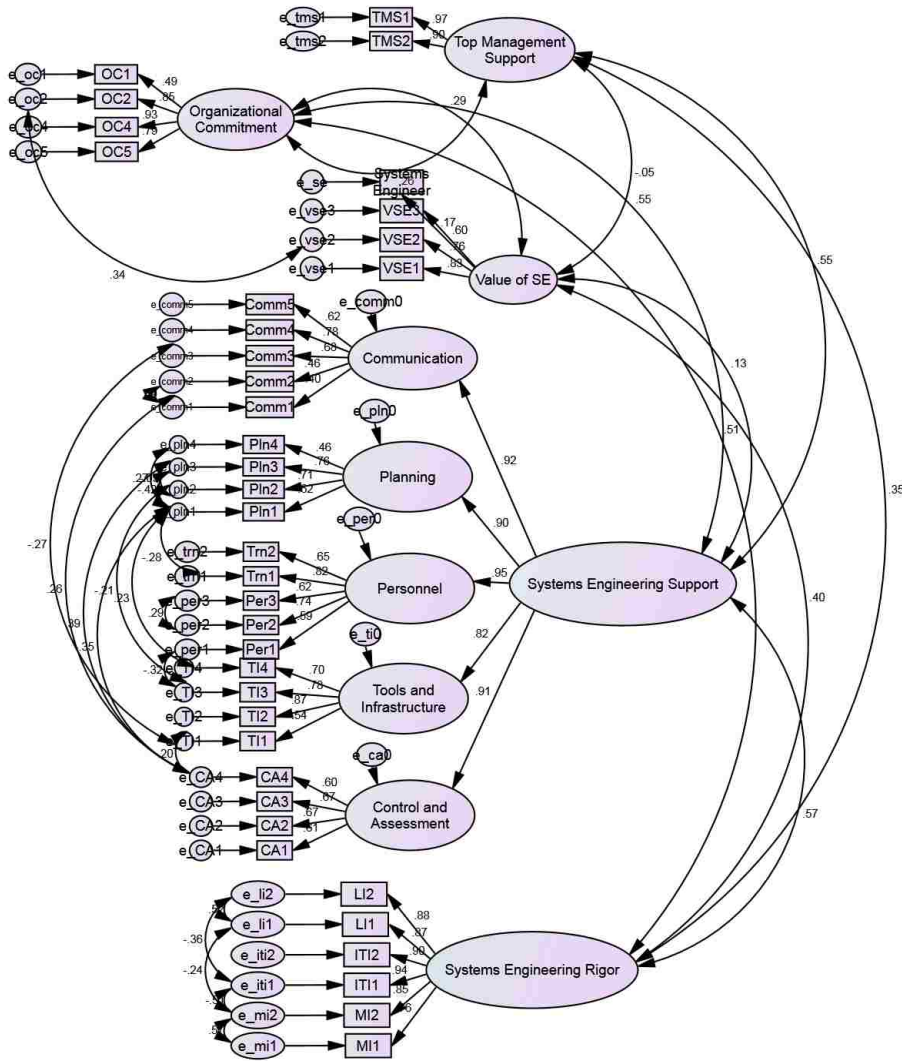

Figure 4.3-23: 2nd Revised Hypothesized Model

A CFA was completed on the 2nd revised hypothesized model. Only two of the four model fit indices satisfied the model fit criteria. TLI and CFI fell below the model fit criteria. The model needed to be revised. First the factor loadings were evaluated for statistical significance. Systems Engineer had such a low factor loading and was barely statically significant, it was deleted from the model. The following covariance paths were deleted because they were not statistically significant: TMS-VSE, VSE-SES, and e_pln2-e_pln3. All other factor loadings had critical ratios greater than 1.96 and were statistically significant at the $p < 0.05$ level. Next, the modification indices were reviewed and covariance

paths between e_per1-2_trn2 and e_ca2-e_comm4 were added. The standardized residual covariance matrix was reviewed next. Based on values above 2.56 in the standardized residual covariance matrix, Comm5, OC1, and Per3 were deleted from the model. The revised model is illustrated in Figure 4.3-24.

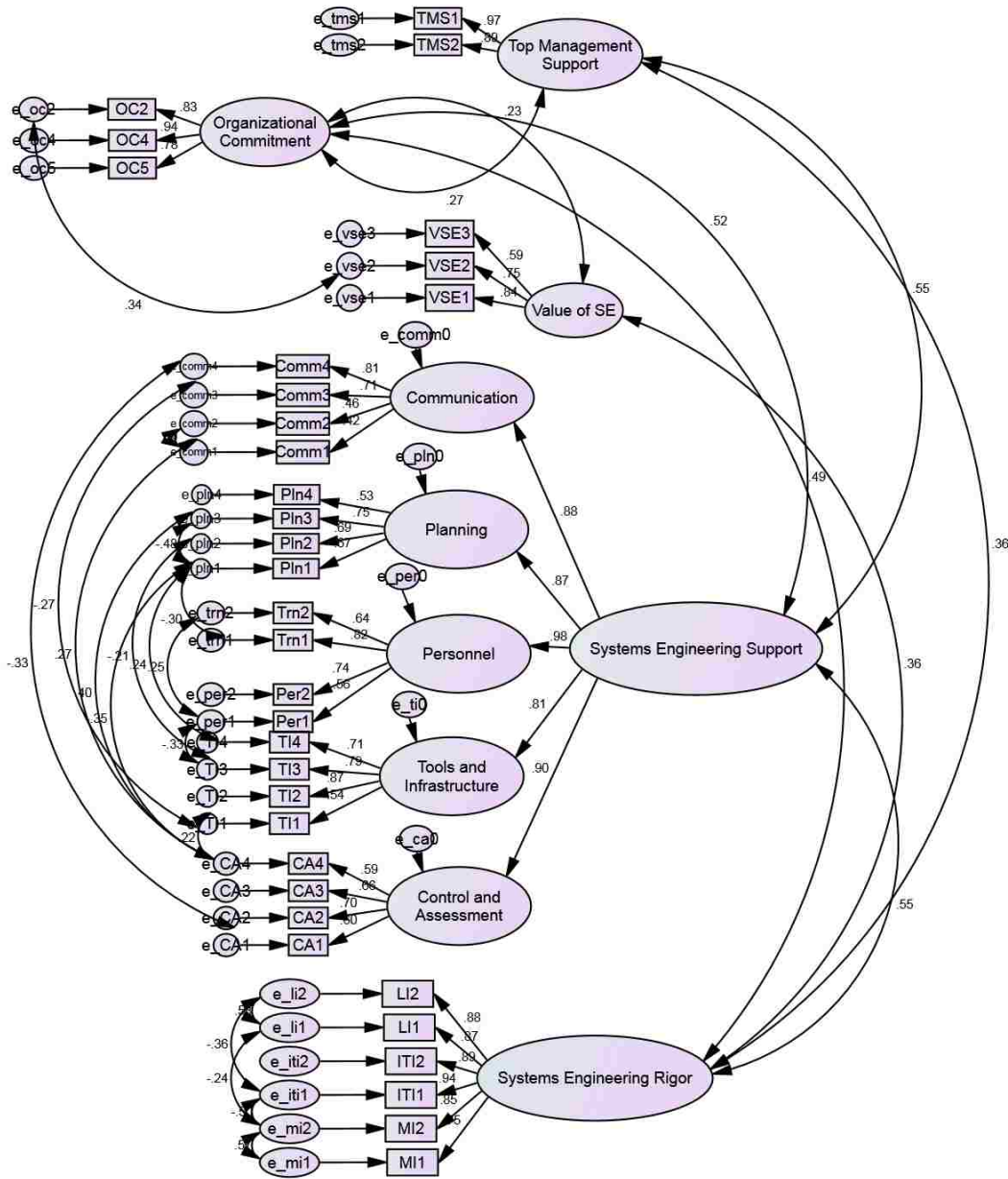

Figure 4.3-24: 3rd Revised Hypothesized Model

Table 4.3-19: Hypothesized Measurement Model Fit Indices

Model Fit Index	Criteria	Initial Model	1 st Revised Model	2 nd Revised Model	3 rd Revised Model
$\frac{\chi^2}{df}$	< 5	1.959	1.820	1.859	1.764
TLI	> 0.90	0.884	0.901	0.875	0.904
CFI	> 0.90	0.895	0.911	0.888	0.915
RMSEA	< 0.08	0.067	0.064	0.065	0.061

A CFA was completed on the 3rd revised hypothesized model. The model fit was evaluated. The revised model satisfied all model fit criteria, which can be seen in Table 4.3-19. All of the correlations of the remaining latent constructs had a critical ratio greater than 1.96 and was significant at a $p < 0.001$ level. Descriptive statistics were calculated for the latent constructs. Table 4.3-20 contains the descriptive statistics, Cronbach’s alpha, and correlations between the latent constructs of the hypothesized model. The correlation between SES and SER was 0.583. The scales for each of the latent constructs were greater than 0.7, which shows good reliability.

Table 4.3-20: Descriptive Statistics, Cronbach’s α , and Correlations of Latent Constructs

	Mean	Std. Deviation	Cronbach’s α	Correlation				
				OC	TMS	VSE	SES	SER
OC	4.550	0.690	0.883	---				
TMS	4.195	1.006	0.930	0.274	---			
VSE	4.173	0.808	0.762	0.226	deleted	---		
SES	3.767	0.897	0.917	0.521	0.546	deleted	---	
SER	4.098	0.772	0.947	0.494	0.364	0.355	0.549	---

SER = Systems Engineering Rigor, TMS = Top Management Support, OC = Organizational Commitment, Com = Communication, T&I = Tools and Infrastructure, C&A = Controls and Assessment

* $p < 0.001$

4.3.3.2 Assessing Model Validity

In structural equation modeling, validity is defined as the degree to which a model (or model results) accurately measures the construct it is intended to measure (Hair et al., 2014; Hoyle, 2012; Kline, 2011; Schumacker & Lomax, 2010). This concept can also be described as construct validity. In systems engineering terms, validity can be considered the verification and validation of the model. There are two types of construct validity that was evaluated in this study: convergent validity and discriminant validity.

4.3.3.2.1 Convergent Validity

SEM researchers describe convergent validity as having evidence showing that there is adequate overlap of variables measuring a particular construct, demonstrated by having a large portion of variance in common (Hair et al., 2014; Hoyle, 2012; Kline, 2011; Schumacker & Lomax, 2010). Identifying evidence of convergent validity is one part of validating the model. Item reliability (or factor loadings), average variance extracted (AVE) must support these results, and construct reliability (CR) are all used to identify convergent reliability (Hair et al., 2014). Indicator reliability was evaluated in Section 4.3.1 and 4.3.2, however, it was re-evaluated based on the revisions made to the hypothesized model and is shown in Table 4.3-21. The reliability of all indicators (factor loadings) were statistically significant at $p < 0.001$ level with critical ratios greater than 1.96.

Table 4.3-21: Convergent Validity

Construct	Indicator	Item Reliability (Factor Loadings)	Cronbach's α	CR	AVE
SE Rigor	MI1	0.753	---	0.947	0.748
	MI2	0.848	---		
	IT11	0.941	---		
	IT12	0.896	---		
	LI1	0.871	---		
	LI2	0.880	---		
SE Support	Communication	0.881	0.740	0.949	0.790
	Planning	0.868	0.726		
	Personnel	0.977	0.794		
	T&I	0.811	0.802		
	C&A	0.900	0.732		
Top Mgmt. Support	TMS1	0.973	---	0.933	0.874
	TMS2	0.894	---		
Org. Commitment	OC2	0.834	---	0.889	0.730
	OC4	0.938	---		
	OC5	0.783	---		
Value of SE	VSE1	0.840	---	0.773	0.537
	VSE2	0.749	---		
	VSE3	0.586	---		

NOTE: All factor loadings were statistically significant at the $p < 0.001$ level

There are a few ways to evaluate convergent validity amongst measures of a construct. The first way is to evaluate the factor loadings. Standardize factor loadings that are statistically significant and above 0.5 (ideally above 0.7) show evidence of strong convergent validity (Hair et al., 2014). It can be seen in Table 4.3-21 that all factor loadings were statistically significant at the $p < 0.001$ level and fourteen of the sixteen standardize factor loadings were above 0.5, with eleven out of the sixteen factor

loadings greater than 0.7. A second way to evaluate convergent validity is to calculate AVE. AVE is the mean variance of the items loading on a construct and is calculated using the equation (1) below.

$$AVE = \frac{\sum_{i=1}^n \lambda_i^2}{n} \quad (1)$$

Where λ is the standardize factor loading and n is the number of items. An AVE value greater than 0.5 suggests adequate convergent validity (Hair et al., 2014). Table 4.3-21 shows that all AVE values were above 0.5 which shows good convergent validity. The third way to assess convergent reliability is to CR. CR is calculated using equation (2) below.

$$CR = \frac{(\sum_{i=1}^n \lambda_i)^2}{(\sum_{i=1}^n \lambda_i)^2 + (\sum_{i=1}^n \theta_i)} \quad (2)$$

Where λ is the standardize factor loading, θ is the error variance and n is the number of items. It's generally believed that a CR greater than 0.7 shows good construct reliability, however a CR value between 0.6 and 0.7 is acceptable if other indicators of construct validity is good (Hair et al., 2014). As illustrated in Table 4.3-21, all CR values were 0.773 or greater, which demonstrated good convergent validity. All methods of assessing convergent validity were satisfied, indicating that there was adequate overlap of variables measuring the constructs of this study.

4.3.3.2.2 Discriminant Validity

Many SEM and multivariate analysts describe discriminant validity as the degree to which a construct differs from other constructs (Hair et al., 2014; Hoyle, 2012; Kline, 2011; Schumacker & Lomax, 2010). Discriminant validity is considered one of the components of construct validity. For a construct to have a high discriminant validity, it suggests that the construct uniquely measures a phenomenon other constructs do not measure (Hair et al., 2014). Hair describes a rigorous test of discriminant validity as comparing the square root of AVE of a given construct against its correlation with

another construct. This was done for the hypothesized model of this study and the results are documented in Table 4.3-22. The correlation between SES and SER was 0.577, which was less than the square root of the AVE for either construct. This demonstrated good evidence of discriminant validity.

Table 4.3-22: Discriminant Validity

Constructs	VSE	TMS	OC	SES	SER
VSE	0.733				
TMS	-0.048	0.934			
OC	0.282	0.262	0.857		
SES	0.126	0.548	0.540	0.890	
SER	0.401	0.345	0.507	0.577	0.868

Factor Correlations. Square root of AVE on the diagonal.

SER = Systems Engineering Rigor, TMS = Top Management Support, OC = Organizational Commitment, Com = Communication, T&I = Tools and Infrastructure, C&A = Controls and Assessment

4.4 Structural Equation Modeling

Confirmatory factor analysis was used to evaluate the measurement models of the latent constructs of the study. Once adequate model fit and validity was achieved, the structural relationships between the latent constructs were examined. The structural model of this study was evaluated using structural equation modeling (SEM). The structural model was developed based on the hypothesized research model (Figure 3.4-1). The structural model is illustrated in Figure 4.4-1. Demographics (control variables) such as Organization Size, Organization Type, Career Level, Role, and Launch Vehicle Experience were added to the model to gain additional insight.

Table 4.4-1: Hyper Model Selected Variable Summary

Selected Variable Summary	
Observed, exogenous variables	<ul style="list-style-type: none"> Organization Type Career Level LV experience Organization Size Number of Projects Role
Unobserved, endogenous variables	<ul style="list-style-type: none"> Systems Engineering Rigor Systems Engineering Support Control and Assessment Tools and Infrastructure Planning Personnel Organizational Commitment Communication Value of Systems Engineering
Unobserved, exogenous variables	<ul style="list-style-type: none"> Top Management Support

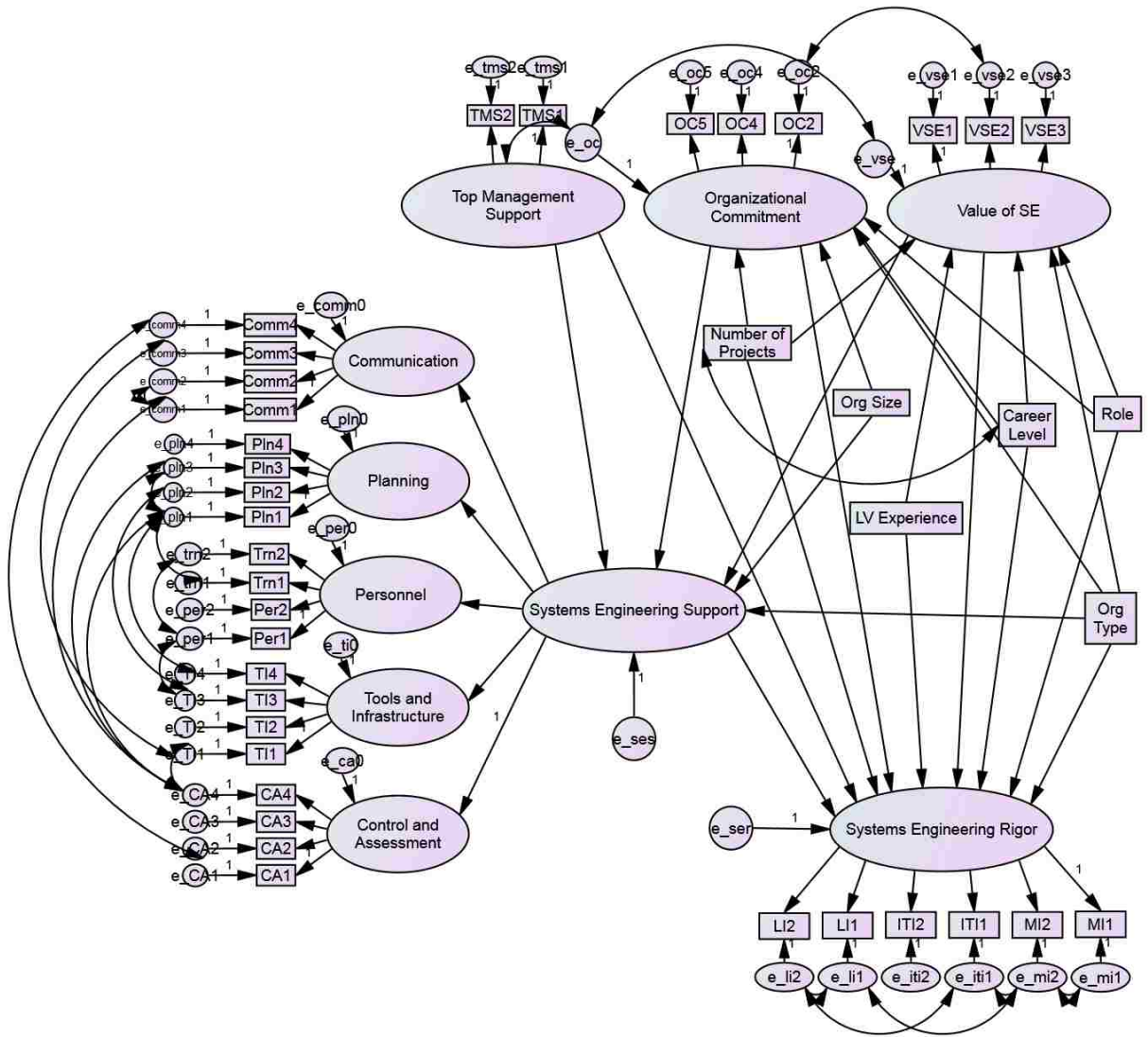

Figure 4.4-1: Hypothesize Structural Model (Hyper Model)

4.4.1 Validating the Structural Model

A composite model from the hypothesize model was created to evaluate the structure of the model. *IBM SPSS Amos 25* was used to impute the observed variables of the model and developed a scale score for each construct. The composite model was constructed using the imputed variables. Using a

composite model in SEM is more efficient and effective in providing model fit compared to the hyper model (Landis, Beal, & Tesluk, 2000). The composite model includes all endogenous and exogenous variables of the hypothesized model and is illustrated in Figure 4.4-2.

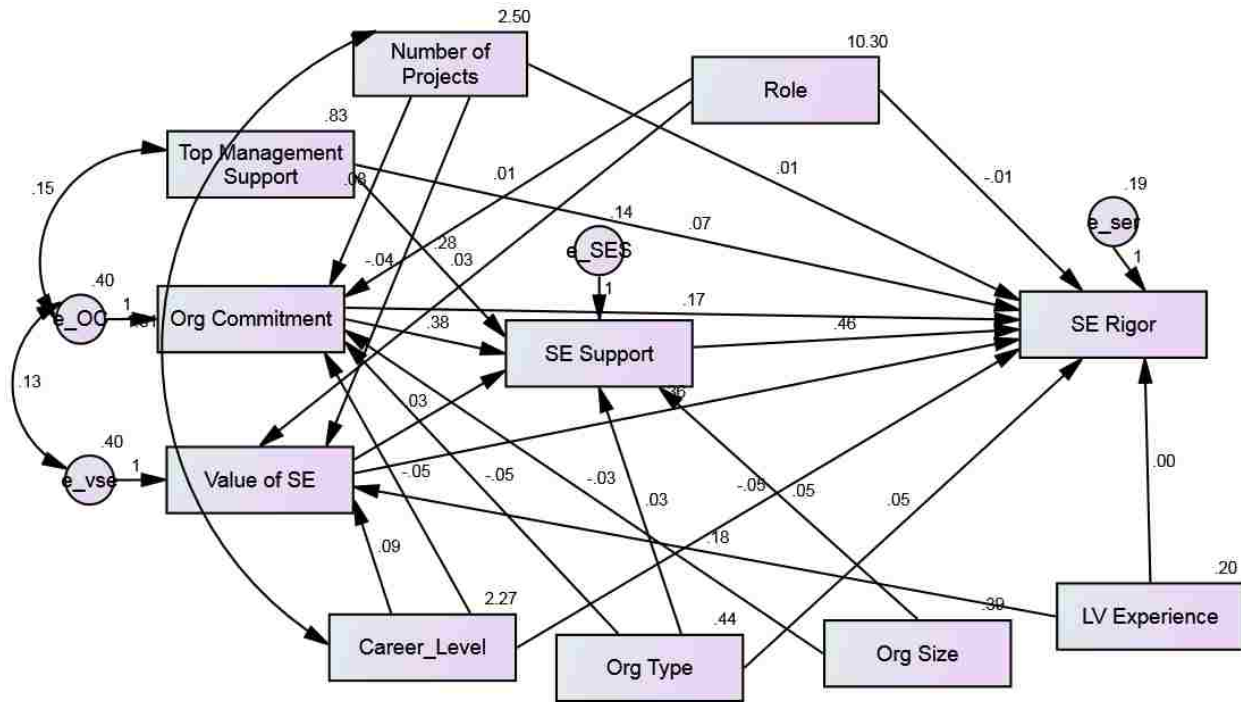

Figure 4.4-2: Hypothesized Structural Model (Composite Model)

The hypothesized structural model in Figure 4.4-2 was tested. Model fit indices were reviewed, and all four of the model fit indices satisfied the specified criteria. However, after parameter estimates in Table 4.4-3 were reviewed. There were several factor loadings that were not statistically significant (critical ratio was < 1.96). All paths that were not statistically significant were removed from the model. LV Experience, Org Size, and Org Type were removed since they no longer had structural paths associated with them that were statistically significant. The 1st revised model can be found in Figure 4.4-3.

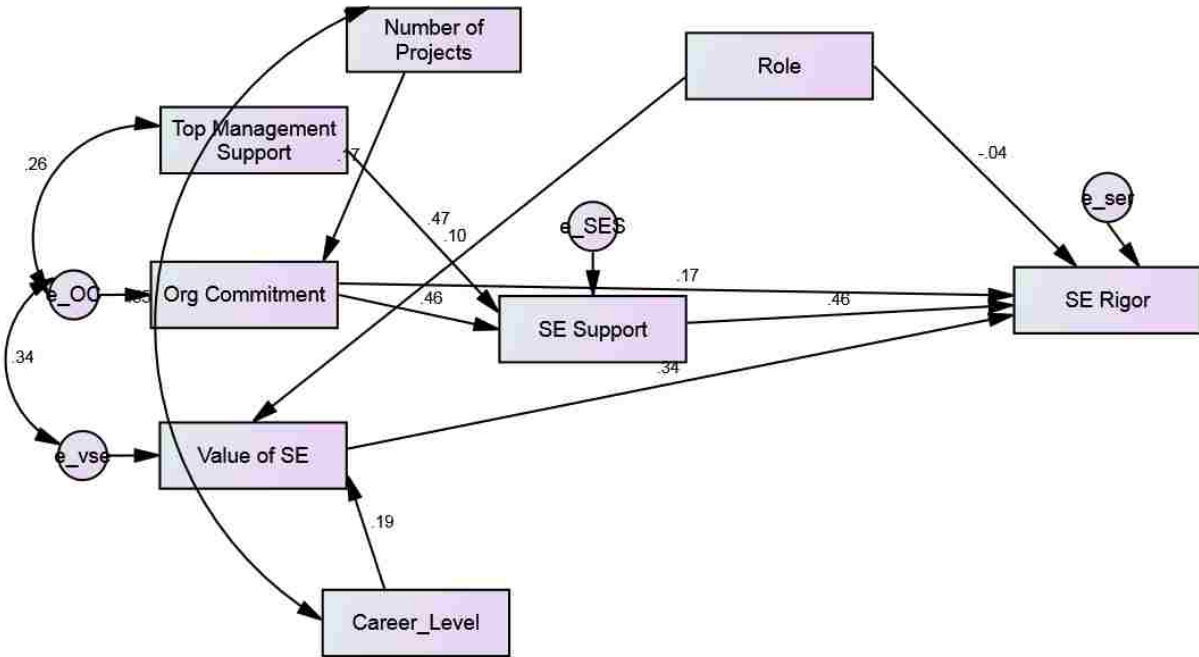

Figure 4.4-3: 1st Revised Hypothesized Structural Model (Composite Model)

The 1st revised model was tested and model fit indices satisfied the model fit criteria. The parameter estimates were reviewed and $SE\ Rigor \leftarrow Role$ (-0.804) and $Value\ of\ SE \leftarrow Role$ (1.594) had a critical ratio < 1.96 and was not statistically significant, thus Role (including its two structural paths) was removed from the model. There were no modifications suggested by the modification indices that were greater than 3. The standardized residual covariance matrix was also examined and all values were under the 2.56 threshold. The 2nd revised model can be found in Figure 4.4-4.

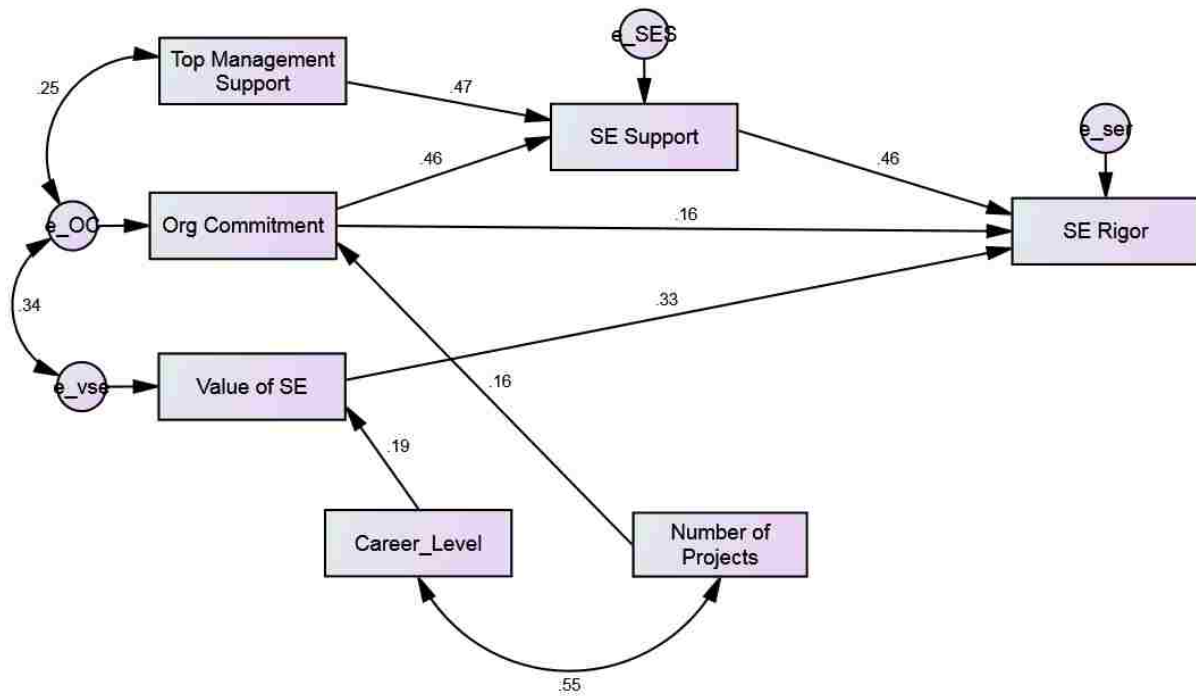

Figure 4.4-4: 2nd Revised Hypothesized Structural Model (Composite Model)

The second revised model was tested. All model fit indices satisfied the criteria. The parameter estimates were examined (Table 4.4-3), and all parameters had a critical ratio greater than 1.96 and were statistically significant at the $p < 0.05$ level. The modification indices were reviewed, and there were no modification index values that exceeded 4. The standardized residual covariance matrix was also reviewed, and there were no values that exceeded the 2.56 threshold.

Table 4.4-2: Structural Model Fit Indices

Model Fit Index	Criteria	Initial Model	1 st Revised Model	2 nd Revised Model
χ^2	< 5	1.247	1.335	1.025
$\frac{\chi^2}{df}$				
TLI	> 0.90	0.968	0.977	0.999
CFI	> 0.90	0.983	0.987	0.999
RMSEA	< 0.08	0.035	0.041	0.011

Table 4.4-3: Unstandardized Regression Estimates

	Hypothesized Model				1 st Revised Model				2 nd Revised Model			
	Estimate	S.E.	C.R.	P	Estimate	S.E.	C.R.	P	Estimate	S.E.	C.R.	P
OC <--- OT	-0.048	0.060	-0.799	0.424	Deleted				Deleted			
OC <--- OS	-0.025	0.065	-0.388	0.698	Deleted				Deleted			
VSE <--- CL	0.088	0.035	2.490	0.013	0.083	0.029	2.889	0.004	0.083	0.029	2.872	0.004
VSE <--- LVE	0.176	0.092	1.909	0.056	Deleted				Deleted			
VSE <--- Role	0.029	0.014	2.079	0.038	0.021	0.013	1.594	0.111	Deleted			
OC <--- Role	0.006	0.013	0.442	0.659	Deleted				Deleted			
OC <--- CL	-0.048	0.034	-1.408	0.159	0.083	0.029	2.889	0.004	Deleted			
OC <--- NP	0.076	0.032	2.349	0.019	0.069	0.026	2.634	0.008	0.067	0.026	2.557	0.011
VSE <--- NP	-0.041	0.034	-1.204	0.229	Deleted				Deleted			
SES <--- OT	0.025	0.039	0.645	0.519	Deleted				Deleted			
SES <--- OC	0.381	0.044	8.566	***	0.386	0.042	9.219	***	0.386	0.042	9.209	***
SES <--- VSE	0.028	0.042	0.679	0.497	Deleted				Deleted			
SES <--- TMS	0.280	0.030	9.423	***	0.278	0.030	9.369	***	0.278	0.030	9.374	***
SES <--- OS	0.046	0.042	1.108	0.268	Deleted				Deleted			
SER <--- OT	0.047	0.046	1.021	0.307	Deleted				Deleted			
SER <--- CL	-0.046	0.025	-1.822	0.069	Deleted				Deleted			
SER <--- LVE	-0.005	0.069	-0.073	0.942	Deleted				Deleted			
SER <--- Role	-0.011	0.010	-1.164	0.244	-0.008	0.010	0.804	0.421	Deleted			
SER <--- TMS	0.067	0.042	1.583	0.113	Deleted				Deleted			
SER <--- OC	0.168	0.062	2.699	0.007	0.165	0.063	2.631	0.009	0.161	0.063	2.572	0.010
SER <--- VSE	0.364	0.052	7.006	***	0.330	0.051	6.450	***	0.326	0.051	6.403	***
SER <--- SES	0.459	0.083	5.531	***	0.539	0.071	7.642	***	0.543	0.071	7.682	***
SER <--- NP	0.012	0.024	0.509	0.611	Deleted				Deleted			

CL = Career Level, LVE = Launch Vehicle Experience, NP = Number of Projects, OC = Organizational Commitment, OS = Organization Size, OT = Organization Type, SER = Systems Engineering Rigor, SES = Systems Engineering Support, VSE = Value of Systems Engineering

Table 4.4-4: Standardized Estimates of 2nd Revised SE Support – SE Rigor Model

			Standardized Estimate (β)	S.E.	C.R.	P
Organizational Commitment	<---	Number of Projects	0.164	0.026	2.557	0.011
Value of SE	<---	Career Level	0.189	0.029	2.872	0.004
SE Support	<---	Organizational Commitment	0.457	0.042	9.209	***
SE Support	<---	Top Management Support	0.466	0.030	9.374	***
SE Rigor	<---	Organizational Commitment	0.162	0.063	2.572	0.010
SE Rigor	<---	Value of SE	0.334	0.051	6.403	***
SE Rigor	<---	SE Support	0.459	0.071	7.682	***

To further scrutinize the model, additional model fit indices were evaluated. The Goodness-of-Fit Index (GFI) was added. GFI is an index that provides an indication of the proportion of variance of the data that is explained by the model (Hair et al., 2014; Kline, 2011). The next model fit index that was added is P_{Close} . P_{Close} provides an indication of how close the model is to fitting the data and should exceed 0.5 (Byrne, 2016). The confidence interval of RMSEA was also evaluated for added scrutiny of the model. The criteria outlined in Table 4.4-5 is consistent with model fit criteria defined by SEM researchers such as: Schumacker and Lomax (2010), Kline (2011), Hoyle (2012), Tabachnick and Fidell (2013), Hair et al. (2014), and Byrne (2016).

Table 4.4-5: Goodness of Fit Indices for SE Support-SE Rigor Structural Model

Model Fit Index	Criteria	Final Revised Modal
Chi-Square (χ^2)	low	11.279
Degrees of Freedom (df)	> 0	11
Probability value (P)	> 0.05	0.420
$\frac{\chi^2}{df}$	< 5	1.025
Goodness-of-Fit Index (GFI)	> 0.90	0.985
Tucker-Lewis Index (TLI)	> 0.90	0.999
Comparative Fit Index (CFI)	> 0.90	0.999
Root Mean Square Error Approximation (RMSEA)	< 0.08	0.011
90% Confidence Interval (Lo90 – Hi90)	< 0.05 – 0.08	0.00 – 0.075
Probability of closeness of fit (P_{close})	> 0.5	0.775

The 2nd revised structural model of the systems engineering support – systems engineering rigor structural model showed the best model fit. The χ^2/df (1.025), TLI (0.999), CFI (0.999), and RMSEA (0.011) showed improvements over previous revisions of the model. All four of these model fit indices satisfied model fit criteria. The additional model fit indices (GFI, 90% Confidence Interval, and P_{close}) also satisfied model fit criteria. All goodness of fit indices satisfied model fit criteria which showed that the 2nd revised hypothesized model show an excellent fit of the data. The goodness of fit measures support that the 2nd revised model was an adequate representation of the hypothesized constructs. The standardized regression weights of the structural paths in Table 4.4-4 were used to test the hypotheses of this study.

4.4.2 Hypothesis Testing

The structural model was validated and adequate model fit was achieved prior to testing the hypotheses. The hypotheses identified in at the beginning of the study (Section 1.3) were as follows:

- *H₁: Systems engineering culture has a direct effect on systems engineering rigor.*
- *H₂: Systems engineering support has a direct effect on systems engineering rigor.*
- *H₃: Systems engineering culture has a direct effect on systems engineering support.*
- *H₄: Systems engineering support will mediate the relationship between systems engineering culture and systems engineering rigor.*

Upon completing a CFA on the measurement model of the hypothesized model, it was discovered that there was very high correlation between hypothesized constructs of systems engineering culture and systems engineering support. Communication, one of the latent factors that was originally hypothesized to be a factor of SE Culture, showed very high correlation with all of the factors that composed SE Support. This high correlation would have posed significant challenges to completing a valid SEM study. Based on the findings of the CFA, it showed that Communication was really a measure of the SE Support construct, thus was removed from the SE Culture construct and added as an indicator of SE Support. The remaining factors (Organization Commitment, Top Management Support, and Value of SE), that were originally hypothesized to be indicators of SE Culture remained in the model as individual latent factors to be tested individual. This adjustment to the hypothesized model led to a reciprocal refinement of the research hypotheses. The hypotheses that originally had the SE Culture construct were replaced with the remaining components of SE Culture construct. The adjusted hypotheses are as follows:

H_{1a}: Organizational Commitment has a direct effect on Systems Engineering Rigor.

H_{1b}: Top Management Support has a direct effect on Systems Engineering Rigor.

- H_{1c}: Value of Systems Engineering has a direct effect on Systems Engineering Rigor.*
- H₂: Systems Engineering Support has a direct effect on Systems Engineering Rigor.*
- H_{3a}: Organizational Commitment has a direct effect on Systems Engineering Support.*
- H_{3b}: Top Management Support has a direct effect on Systems Engineering Support.*
- H_{3c}: Value of Systems Engineering has a direct effect on Systems Engineering Support.*
- H_{4a}: Systems Engineering Support will mediate the relationship between Organizational Commitment and Systems Engineering Rigor.*
- H_{4b}: Systems Engineering Support will mediate the relationship between Top Management Support and Systems Engineering Rigor.*
- H_{4c}: Systems Engineering Support will mediate the relationship between Value of Systems Engineering and Systems Engineering Rigor.*

The direct, indirect, and total effects were calculated using *IBM SPSS Amos 25* for the 2nd revised structural model. The effects calculated in Table 4.4-6 showed that the direct effect of Organizational Commitment on SE Rigor was significantly positive ($\beta = 0.162$, $p = 0.046$). This indicated that the more employees involved in the SE process are committed to the organization, the more rigor they apply the systems engineering process. This confirmed that the data supported H_{1a}.

The effects of the revised structural model showed that there was no direct effect on SE Rigor by Top Management Support. This suggested Top Management Support was not a predictor of SE Rigor, thus H_{1b} was not supported. However, the revised structural model showed that the direct effect of Value of SE on SE Rigor was significantly positive ($\beta = 0.334$, $p = 0.008$). This positive relationship indicated that the more the employee recognizes the value of the SE process, the more rigorous and beneficial they perceive the SE process to be. Hence, H_{1c} was confirmed. The model also showed that the direct effect of SE Support on SE Rigor was significantly positive ($\beta = 0.459$, $p = 0.005$). This suggests that the more

support there is for the SE process, the more rigor is perceived to be applied to process. As a result, H₂ was confirmed.

Table 4.4-6 showed that the direct effect of Organizational Commitment on SE Support was significantly positive ($\beta = 0.457, p = 0.011$). This relationship indicates that the more employee is committed to the organization, the more systems engineering support is applied. Thus, H_{3a} was confirmed. The model also showed that the direct effect of Top Management Support on Systems Engineering Support was significantly positive ($\beta = 0.466, p = 0.012$), indicating that the more top management supports the SE process, the more employees and organizations provide support for the SE process. As a result, H_{3b} was confirmed. The final revised structural model did not show a direct effect of Value of SE on SE Support, thus H_{3c} was not confirmed.

Table 4.4-6: Direct, Indirect and Total Effects

		NP		TMS		CL		OC		SES		VSE	
		Estimate	P	Estimate	P	Estimate	P	Estimate	P	Estimate	P	Estimate	p
OC	Direct	0.164	0.011	---	---	---	---	---	---	---	---	---	---
	Indirect	---	---	---	---	---	---	---	---	---	---	---	---
	Total	0.164	0.011	---	---	---	---	---	---	---	---	---	---
SES	Direct	---	---	0.466	0.012	---	---	0.457	0.011	---	---	---	---
	Indirect	0.075	0.007	---	---	---	---	---	---	---	---	---	---
	Total	0.075	0.007	0.466	0.012	---	---	0.457	0.011	---	---	---	---
VSE	Direct	---	---	---	---	0.189	0.009	---	---	---	---	---	---
	Indirect	---	---	---	---	---	---	---	---	---	---	---	---
	Total	---	---	---	---	0.189	0.009	---	---	---	---	---	---
SER	Direct	---	---	---	---	---	---	0.162	0.046	0.459	0.005	0.334	0.008
	Indirect	0.061	0.003	0.214	0.005	0.063	0.001	0.210	0.012	---	---	---	---
	Total	0.061	0.003	0.214	0.005	0.063	0.011	0.371	0.010	0.459	0.005	0.334	0.008

CL = Career Level, NP = Number of Projects, OC = Organizational Commitment, SER = Systems Engineering Rigor, SES = Systems Engineering Support, TMS = Top Management Support, and VSE = Value of Systems Engineering.

Next, the mediation effects of SE Support was examined. The mediation effects of SE Support are in Table 4.4-7. From examining the table, the indirect effect of Organizational Commitment on SE Rigor was significantly positive ($\beta = 0.210$, $p = 0.012$). When the direct effect of Organizational Commitment on Rigor without mediation ($\beta = 0.172$, $p = 0.002$), was compared to the direct effect of Organizational Commitment on SE Rigor with mediation ($\beta = 0.162$, $p = 0.010$), there was a decrease in the standardized regression estimate, which was also statistically significant. This showed that Organizational Commitment was partially mediated by SE Support, which supports H_{4a}.

Table 4.4-7 shows that the indirect effect of Top Management Support on SE Rigor ($\beta = 0.186$, $p = 0.004$) was significantly positive. Both the direct effect without mediator ($\beta = 0.091$, $p = 0.073$) and the direct effect with mediator ($\beta = 0.090$, $p = 0.134$) were not statistically significant. This finding shows that there was complete mediation by SE Support of the relationship between Top Management Support and SE Rigor. This implied that as Top Management Support increases, facilitation of SE support increases, which increases the rigor applied to the SE process. Thus indicating that H_{4b} was supported.

The effects of Value of SE on SE Rigor can also be found in Table 4.4-7. The table shows that the direct effect of Value of SE on SE Rigor without mediation is significantly positive ($\beta = 0.334$, $p < 0.001$). The direct effect with mediation was also significantly positive ($\beta = 0.332$, $p < 0.001$). However, the indirect effect was not statistically significant ($\beta = 0.015$, $p = 0.409$). These findings showed that there was no mediation by SE Support on the relationship between Value of SE and SE Rigor. H_{4c} was not supported by the findings.

Table 4.4-7: Mediation Effects

Relationship	Direct without Mediator		Direct with Mediator		Indirect	
	Std. Estimate(β)	p	Std. Estimate	p	Std. Estimate	p
OC→SES→SER	0.172	0.002	0.162	0.010	0.210	0.012
TMS→SES→SER	0.091	0.073	0.090	0.134	0.186	0.004
VSE→SES→SER	0.334	***	0.332	***	0.015	0.409

OC = Organizational Commitment, SER = Systems Engineering Rigor, SES = Systems Engineering Support, TMS = Top Management Support, VSE = Value of Systems Engineering

*** p < 0.001

Table 4.4-8: Hypothesis Testing Results

Hypothesis	Description	β	t	Supported?
H _{1a}	Organizational Commitment has a direct effect on Systems Engineering Rigor.	0.162	2.572*	Yes
H _{1b}	Top Management Support has a direct effect on Systems Engineering Rigor.	0.067	1.583	No
H _{1c}	Value of Systems Engineering has a direct effect on Systems Engineering Rigor.	0.334	6.403**	Yes
H ₂	Systems Engineering Support has a direct effect on Systems Engineering Rigor.	0.459	7.682**	Yes
H _{3a}	Organizational Commitment has a direct effect on Systems Engineering Support.	0.457	9.209**	Yes
H _{3b}	Top Management Support has a direct effect on Systems Engineering Support.	0.466	9.374**	Yes
H _{3c}	Value of Systems Engineering has a direct effect on Systems Engineering Support.	0.028	0.679	No
H _{4a}	Systems Engineering Support will mediate the relationship between Organizational Commitment and Systems Engineering Rigor.		Partial Mediation	
H _{4b}	Systems Engineering Support will mediate the relationship between Top Management Support and Systems Engineering Rigor.	0.186	2.889*	Yes
H _{4c}	Systems Engineering Support will mediate the relationship between Value of Systems Engineering and Systems Engineering Rigor.		No Mediation	

β = standardized path coefficient, t = critical ratio, *p < 0.001, **p < 0.01

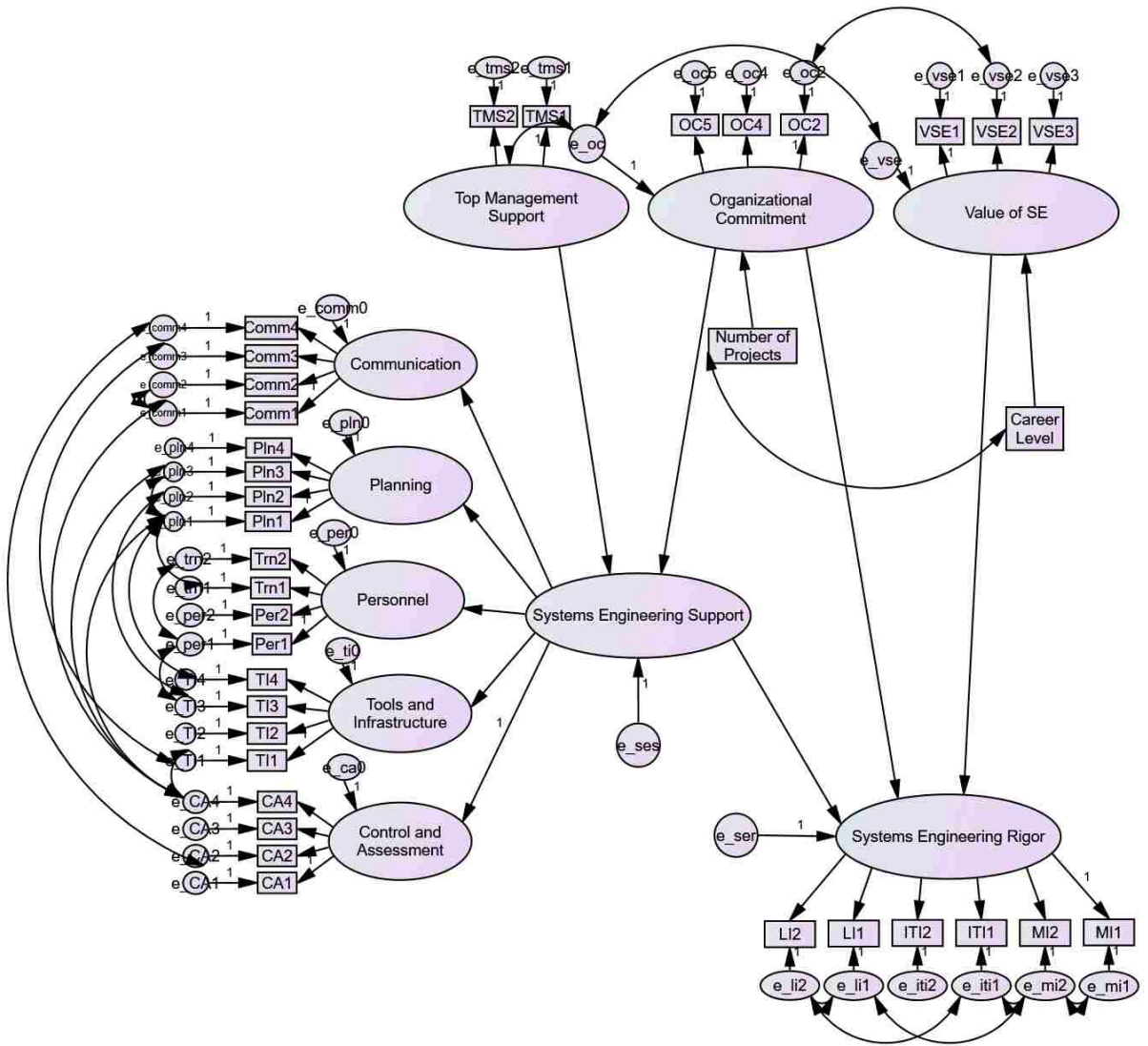

Figure 4.4-5: Final Structural Hyper Model

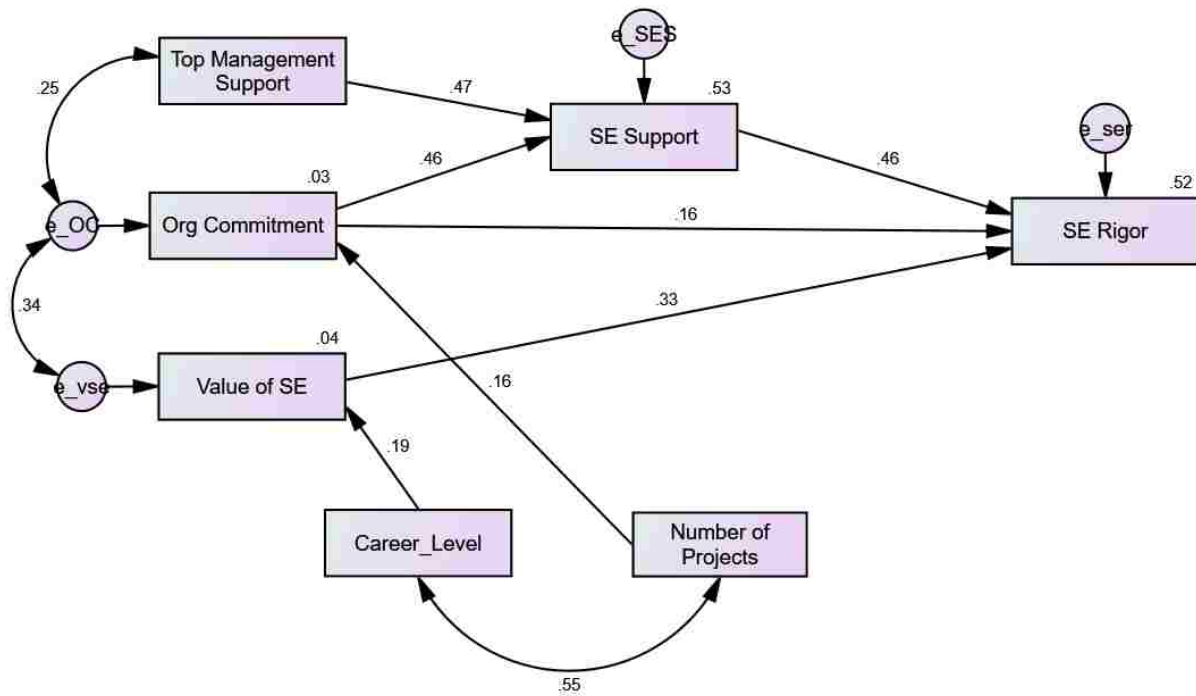

Figure 4.4-6: Final Structural Composite Model

A summary of the hypothesis testing can be found in Table 4.4-8. Seven out of the ten hypotheses of this study were supported by the data and final structural model. Only H_{1b}, H_{3c}, and H_{4c} were not supported by the data. Overall, the data and the model provided adequate information to test the hypotheses.

The final structural model can be found in Figure 4.4-5 and Figure 4.4-6. There were no changes from the 2nd revised model to the final model. Each path of the model was significant. The model accounted for 53% of the variance of SE Support, 52% of the variance in SE Rigor, 4% of the variance in Value of SE, and 3% of Organizational Commitment.

CHAPTER V: DISCUSSION, LIMITATIONS, IMPLICATIONS, FUTURE RESEARCH, AND CONCLUSION

The main focus of this study was to analyze the factors that affect systems engineering rigor in launch vehicle organizations in the United States. Another objective of the study was to develop a model that explains systems engineering culture, systems engineering support, and systems engineering rigor. This chapter contains the discussion of the research results and conclusion. Implications and suggestions for future research are also discussed in this chapter.

5.1 Discussion

Section 3.5.1 provided a description of each factor relevant to this study. The construct of each variable was developed based on the literature review completed in Chapter II. The responses to the survey instrument provided the data to analyze the relationships among the constructs of the study. The primary constructs that were analyzed were Systems Engineering Culture, Systems Engineering Support, and Systems Engineering Rigor. The Systems Engineering Culture construct was originally believed to be measured by four latent factors: Top Management Support, Organizational Commitment, Value of Systems Engineering, and Communication. The Systems Engineering Support construct was initially believed to be measured by the following latent factors: Planning, Personnel, Tools & Infrastructure, and Control & Assessment. The Systems Engineering Rigor construct was measured by six survey statements.

Confirmatory Factor analysis results showed that Communication had a very high correlation with each of the four factors (correlations ranged from 0.707 to 0.845) of SE Support. None of the other factors of SE Culture exhibited high correlations to the other factors of SE Support. The CFA results suggested that Communication was a measure of the SE Support construct. This was a surprising finding since communication is a fundamental component to cooperation, teamwork, SE culture, and organizational culture (Gill et al., 2005; Reigle, 2015; SEBoK authors, 2016). This could likely be due to

the wording of survey statements that correspond to the Communication construct. The survey statements focused on departments and not the individual. The SE Support construct and SEM models were revised to include Communication as a factor of SE Support, and each remaining factor of SE Culture was tested individually in the model. The research hypotheses were modified to reflect the updated model strategy.

The influence of organizational commitment on SE rigor was the first hypothesis (H_{1a}) that was tested. The study results showed that organizational commitment had a significant influence on the perceived rigor applied to the SE process in reducing launch vehicle problems. Indicating that the more an employee is committed to the organization, the greater the perceived benefit of applying a rigorous SE process. Organizational commitment is a critical indicator when evaluating a cultural aspect of an organization (Alnoaimi, 2015; Alsowayigh, 2014; Fogarty, 2004). Therefore, it is reasonable that a systems engineer who is more committed to the organization would apply more rigor to the SE process.

The influence of top management support on SE rigor was the second hypothesis (H_{1b}) that was examined. The results of the study showed that top management support did not have a significant influence on perceived rigor in the SE process. Indicating that top management support could not be used to predict systems engineering rigor. Although SEBoK authors (2016) consider top management support an enabler of systems engineering in organizations and a key element to systems engineering culture, no literature could be found that directly correlates top management support to perceived SE rigor.

The third hypothesis (H_{1c}) that was examined was the influence of the value of SE on SE rigor. The study results showed that the perceived value of SE had a significant influence on SE rigor. This implies that the more an employee perceives SE as being valuable, the greater the perceived benefit of applying a rigorous SE process. Given the underlying relationship between the fundamental purpose and value of systems engineering is to reduce cost, maintain schedule, and increase technical performance (Eric C. Honour, 2004, 2010) and that SE value can manifest in the launch vehicle industry by reducing launch vehicle issues maintaining, it is comprehensible that value of SE influences SE rigor.

The influence of SE Support on SE Rigor was the next hypothesis (H₂) that was tested. The results of the study showed that SE support had a significant influence on SE rigor. These findings imply that as SE support increases, the perceived benefit of applying a rigorous SE process increases. SE researchers identified SE competencies, tools, and infrastructure as SE enablers (INCOSE, 2011; Oppenheim et al., 2011; SEBoK authors, 2016). Each of these enablers were factors of the SE Support construct, which shows that the study results are consistent with INCOSE's, Oppenheim's, and SEBoK's research.

Organizational Commitment's influence on SE Support (H_{3a}) was examined in this study. The results showed that Organizational Commitment had a significant influence on SE Support. This implies that as systems engineering practitioners are more committed to the organization, the more support is provided to the SE process. Multiple studies identified appropriate tools and infrastructure, timely planning, and appropriate personnel as critical to systems engineering (Blair et al., 2011; Bruff, 2008; Gill et al., 2005; Kaskowitz, 1990; NASA, 2007; Slegers et al., 2012). Each of these critical items identified were factors of the SE Support construct, which shows the results of this study was consistent with other research. It is conceivable that the more an employee is committed to the organization, the more support they would provide to planning, training, use of tools, and collaboration and teamwork.

The sixth hypothesis (H_{3b}) that was tested was the influence of Top Management Support on Systems Engineering Support. Results of the study showed that Top Management Support has a significant influence on Systems Engineering Support. What can be inferred from this is that the more senior leadership's support for SE is perceived, the more support is provided to the SE process. Research completed by Schein (2004), Hogan and Coote (2014), and Chatman and O'Reilly (2016) showed that the leaders of the organization starts, embeds, and transmits their values, beliefs, and assumptions on the organization. This study shows that top management support for SE influences the SE support structure in the organization, which is consistent with the research completed by Schein, Hogan, and Chatman.

The influence of the value of SE on systems engineering support (H_{3c}) was also tested. Study results showed that value of SE does not have a significant influence on SE support. This was a surprising finding. Common sense suggests that the more valuable an employee perceives the SE process to be, the more support would be provided to the SE process. Research completed Elm and Goldenson (2012) and Eric C. Honour et al. (2004) found that it is difficult for employees and organizations to understand the value of or effectiveness of SE because it's difficult to isolate the effect of SE from other effects and that there is typically a limited amount of information available about that demonstrates the effects of SE. This difficulty could partially explain the study results of this study. In addition, survey statements corresponding to value of SE focused on cost, schedule, and technical performance which survey participants may not have had access to that information. The difficulty of isolating the effects of SE coupled with survey statements focused on cost, schedule, and technical performance could explain the study showing a lack of influence of value of SE on SE support.

The eighth hypothesis (H_{4a}) that was examined was the influence of organizational commitment on SE rigor through SE support. Study results showed that organizational commitment had a significant effect on SE support, and this SE support had a significant influence on SE rigor. This implied that an increase in employee commitment to the organization, increases support for SE, and this increase in support increases the perceived benefit of rigorous SE. Research has shown that employee commitment to the organization is a critical aspect of organizational culture (Alsowayigh, 2014; Fogarty, 2004; Schein, 1990, 2004). Testing of hypothesis H_{1a} also showed that organizational commitment had a direct effect on SE rigor without the mediation of SE support. It is understandable that organizational commitment would have a significant influence directly on SE rigor and through SE support. Research by Schein (2004) showed that the more committed an employee is to the organization, the more likely they are to participate in activities that are perceived as beneficial to the organization. Schein's research results are consistent with the findings of this study.

The influence of top management support on SE rigor through SE support (H_{4b}) was tested in this study. Study results showed that top management support had a significant effect on SE support, and this SE support had a significant influence on SE rigor. Test results showed that there was complete mediation by SE Support. This indicated that as perceived support from top management for SE increases, support for SE increases, and this increase in support increases the perceived benefit of rigorous SE. Top management support is a key element to SE culture. Senior leadership support and culture is are SE enablers (INCOSE, 2011; Oppenheim et al., 2011; SEBoK authors, 2016). It's only logical that as senior management's support for SE is perceived by the organization, the organization provides increased support to SE, which in turn increases SE rigor.

The tenth hypothesis (H_{4c}) examined was the influence of value on SE rigor through SE support. Study results showed that had no significant effect on SE support. This indicates that Value of SE was not mediated by SE Support. Similar to what was discussed for H_{3c}, the difficulty of employees to recognize the value of systems engineering due to the difficulty of separating SE from other factors may also explain the results of H_{4c} testing.

Study results also showed that demographics (control variables) had very little impact on any of the factors in the model. It was originally hypothesized that demographics such as: Role in SE, Organization Type, and Organization Size, would have played a significant influence on the factors in the model. Research completed by Schein (2004) and Reigle (2015) suggest these demographic may play a role in the systems engineering culture factors, however this study found no significant effect on those factors. This was another surprising finding in the study. A possible explanation could be that survey statements for organization size categories may have been too broad. Survey participants may have had difficulty choosing the right category for their organization since the organization type survey statement focused on level of government involvement.

5.2 Limitations

Survey responses collected for this study were based on voluntary participants of launch vehicle organizations throughout the United States. Responses that evaluated the factors of SE culture, support, and rigor were based on the perceptions of the participants in the SE process. The responses may have been based on what the survey participants think is ideal or how it should be, and not what they actually believed or observed. In addition, SE participants who may have had a negative attitude towards their management or organization may have been biased towards providing negative responses.

Another limitation is that the survey did not take in to account the risk tolerance of each organization. Each organization may have different risk postures which could affect the way that each organization implements the systems engineering process. For example, organizations that have a roll in national security missions could have a different risk tolerance than that of an organization that is focused on low cost science missions. This could lead to vastly different levels of SE rigor. In addition, an organization's risk posture may vary with each launch, possibly prompting a different level of SE rigor with each launch. Survey responses could have been affected by the risk tolerance of the organization as well as the risk tolerance of the mission during the time the survey response was completed.

5.3 Implications

Despite the limitations identified in Section 5.2, the findings of this study may present a number of implications for both SE research in general and U.S. launch vehicle organizations. This study identified significant factors that could influence the level of rigor applied to the SE process. Previous research has shown that SE impacts cost, schedule, and technical performance (BKCASE Editorial Board, 2014; Elm, 2012; Eric C. Honour, 2004, 2010; INCOSE, 2011; NASA, 2007). Improving the factors that affect SE in launch vehicle organizations could improve the level of rigor applied to the SE process. Prior research identified lack of SE rigor as a significant contributor to the cause of launch vehicle failures

(Chang, 1996; Harland & Lorenz, 2005; Isakowitz et al., 2004; Leung, 2014; Newman, 2001). Improving the factors that influence SE rigor could reduce the number of launch vehicle failures encountered by a launch vehicle organization. Reducing the number of launch vehicle issues and failures could ultimately result in cost and time savings and a more reliable launch vehicle.

This research also identified key factors of systems engineering culture. SE culture is a major enabler of systems engineering in organizations (INCOSE, 2011; Oppenheim et al., 2011; SEBoK authors, 2016). In recognizing the factors of SE and organizational culture, leaders of organizations could make targeted changes to the organization to improve SE culture, which influences the level of rigor in the organization's SE process. The present study identified that perceiving leadership's support for SE, employees being committed to the organization, and employees recognizing the value of SE have a significant impact on the SE framework and rigor applied to the SE process. These are areas that launch vehicle organization leaders could target to improve, that could ultimately lead to cost and time savings while improving launch vehicle technical performance.

Additionally, this study identified that SE support which consists of communication, personnel, tools & infrastructure, control & assessment, and planning, influence SE rigor. These are also areas that an organization could target to improve the level of SE rigor in an organization. Ultimately, the factors and model identified in this study could serve as a framework to evaluate the SE of an organization and identify areas that can be targeted to improve SE rigor. This study provides empirical evidence of top management support, organizational commitment, and perceived value of SE as predictors of SE rigor. The model presented in this study may be generalizable and applicable to other industries considering organization type and size had no significant impact on the research results, and data for this study was collected from various different organization types and sizes.

5.4 Future Research

This study examined the relationships of the factors of SE culture, SE support and SE rigor. The assessment of SE rigor was based on survey respondents' perception of SE rigor in reducing launch vehicle issues. Future research should seek to anchor the SE rigor construct to observed launch vehicle issue statistics of the subject organizations. This could ground the model in observed events rather than perception.

Future research should also seek to include an organizations risk tolerance in similar studies. An organization's risk tolerance could influence the culture of an organization and the level of rigor the organizations applies to SE. Studies should seek to explore the relationships between risk tolerance SE culture, rigor, and support. Including the risk tolerance factor in future research could provide additional fidelity to the model.

Researchers such as Schein (2004), Hogan and Coote (2014), and Reigle (2015) showed that organizational structure has an impact on the culture of the organization. Future research should include organizational structure. The influence of organizational structure on SE culture, support, and rigor should be explored. Including organizational structure could improve the fidelity of the model presented in this study.

5.5 Conclusion

A launch vehicle is a very complex system that often requires a meticulous and methodical interdisciplinary approach to develop, build, and operate. Often, the systems engineering approach of the launch vehicle organization may be as complex as the launch vehicle itself. There are many different ways that systems engineering can be implemented in an organization. Regardless of the systems engineering model or approach, organizational factors have been identified to influence systems

engineering rigor in launch vehicle organizations. Lack of systems engineering rigor has been identified as a contributor to many launch vehicle failures. Therefore, it is critical to identify the factors that may enhance the level of systems engineering rigor.

This study assessed the factors that affect systems engineering rigor in U.S. launch vehicle organizations. A systems engineering rigor model was developed to examine the relationships among perceived organizational commitment, top management support, value of systems engineering, and systems engineering support. The measures of systems engineering support were communication, control and assessment, personnel, planning, and tools and infrastructure. Study results showed that organizational commitment and value of systems engineering both directly and independently play a significant role in enhancing the perceived systems engineering rigor. The results of the study also showed that both organizational commitment and top management support have a significant influence on systems engineering support. The significant influence of top management support on systems engineering rigor was completely mediated by systems engineering support. Systems engineering support was also found to partially mediate the relationship between organizational commitment and systems engineering rigor. The data used in this study was taken from various organizations throughout the U.S. launch vehicle industry, therefore results are generalizable. The model developed in this study accounts for 52% of the variance in systems engineering rigor, 53% of the variance in systems engineering support, 4% of the variance in the value of systems engineering, and 3% of the variance in organizational commitment.

The model presented in this study was an initial attempt to explore the links among systems engineering culture, systems engineering support, and systems engineering rigor. The direct effects of organizational commitment, perceived value of systems engineering, and systems engineering support on perceived systems engineering rigor has not been previously reported in research. Also, the direct effects on organizational commitment and perceived top management support on systems engineering rigor has

not been previously reported in research. Lastly, the mediation by systems engineering support for the relationships between organizational commitment and perceived systems engineering rigor and the relationship between perceived top management support and perceived systems engineering rigor has not been reported in prior research.

In conclusion, the results of this study emphasize the role of organizational factors on rigorous systems engineering. Leaders of launch vehicle organization must emphasize support for systems engineering, illustrate the value of systems engineering, enhance systems engineering support, and improve employees' commitment to the organization, which in turn would lead to rigorous systems engineering and potentially improving launch vehicle success.

APPENDIX A: SURVEY INSTRUMENT

The purpose of this research is to develop a model of the relationships between systems engineering culture, systems engineering support, and systems engineering rigor in launch vehicle organizations.

For the purposes of this study, systems engineering is defined as a methodical interdisciplinary approach to design, build, operate, manage, and retire a system, where these systems must meet stakeholder requirements.

All data obtained from this study is completely anonymous and survey results are aggregated so individuals or organizations cannot be identified. The survey is very brief and will take less than 10 minutes to complete.

Please respond to each question to the best of your knowledge.

1. Which position most closely describes your role in systems engineering in your organization?
(Select all that applies)

- Systems Engineer
- Project Manager
- Sub-system or component level engineer
- Analyst
- Manager
- Design Engineer
- Manufacturing Engineer
- Operations Engineer
- Integration Engineer
- Test Engineer
- Engineering Support
- Other: _____

2. How many years of experience have you had in or supporting systems engineering?

Mark only one box.

- 1 - 5 years 5 - 10 years 10 - 15 years 15 - 20 years 20 years or more

3. How many projects have you worked on?

Mark only one box.

- 1 - 5 projects 6 - 10 projects 11 - 15 projects 15 - 20 projects 20 or more projects

4. Has most of your systems engineering experience come in the launch vehicle industry?

Mark only one box.

- Yes No

5. Choose the answer which more closely describes your organization.
Mark only one box.

- Private company with very little government involvement
 Private company with some government involvement
 Private company with a lot of government involvement
 Government agency
 Other: _____

6. Choose the answer that best describes the size of your organization.
Mark only one box.

- Small (100 employees or less) Medium (101-999 employees) Large (1000 employees or more)

7. Senior management strongly supports the systems engineering process.
Mark only one box.

- Strongly disagree Disagree Neutral Agree Strongly agree

8. Senior management believes a strong systems engineering process adds value to the organization.
Mark only one box.

- Strongly disagree Disagree Neutral Agree Strongly agree

9. Senior management communicates its support for systems engineering to the organization.
Mark only one box.

- Strongly disagree Disagree Neutral Agree Strongly agree

10. Senior management supports skipping a systems engineering step if it will help the organization save money.

Mark only one box.

Strongly disagree Disagree Neutral Agree Strongly agree

11. Senior management supports skipping a systems engineering step if it will help the organization meet schedule goals.

Mark only one box.

Strongly disagree Disagree Neutral Agree Strongly agree

12. Practicing good systems engineering reduces launch vehicle cost.

Mark only one box.

Strongly disagree Disagree Neutral Agree Strongly agree

13. Practicing good system engineering reduces launch vehicle schedule delays.

Mark only one box.

Strongly disagree Disagree Neutral Agree Strongly agree

14. Practicing good system engineering improves launch vehicle performance.

Mark only one box.

Strongly disagree Disagree Neutral Agree Strongly agree

15. My organization emphasizes effective communication between departments such as design, manufacturing, and operations.

Mark only one box.

Strongly disagree Disagree Neutral Agree Strongly agree

16. My organization emphasizes effective communication among the various engineering disciplines (disciplines such as avionics, structures, propulsion, environments, software, etc).
Mark only one box.

Strongly disagree Disagree Neutral Agree Strongly agree

17. Management has an open door policy for discussing systems engineering issues.
Mark only one box.

Strongly disagree Disagree Neutral Agree Strongly agree

18. There is good communication about systems engineering items in the workplace.
Mark only one box.

Strongly disagree Disagree Neutral Agree Strongly agree

19. Documenting detailed rationale for technical decisions is highly encouraged.
Mark only one box.

Strongly disagree Disagree Neutral Agree Strongly agree

20. I am willing to put in a great amount of effort beyond what is normally expected in order to help my organization be successful.
Mark only one box.

Strongly disagree Disagree Neutral Agree Strongly agree

21. I speak highly of this organization to my friends and family as a great place to work.
Mark only one box.

Strongly disagree Disagree Neutral Agree Strongly agree

22. I find that my values and my organization's values are very similar.
Mark only one box.

Strongly disagree Disagree Neutral Agree Strongly agree

23. I am proud to tell others that I work for this organization.
Mark only one box.

Strongly disagree Disagree Neutral Agree Strongly agree

24. I really care about the fate of this organization.
Mark only one box.

Strongly disagree Disagree Neutral Agree Strongly agree

25. This is the best launch vehicle organization to work for.
Mark only one box.

Strongly disagree Disagree Neutral Agree Strongly agree

26. My organization has a documented plan on how systems engineering should be implemented.
Mark only one box.

Strongly disagree Disagree Neutral Agree Strongly agree

27. My role in systems engineering is clearly identified.
Mark only one box.

Strongly disagree Disagree Neutral Agree Strongly agree

28. My organization identifies how all technical engineering disciplines are integrated.
Mark only one box.

Strongly disagree Disagree Neutral Agree Strongly agree

29. There was a systems engineering plan in place at the beginning of launch vehicle development.
Mark only one box.

Strongly disagree Disagree Neutral Agree Strongly agree

30. My organization understands the skills needed to successfully execute systems engineering.
Mark only one box.

Strongly disagree Disagree Neutral Agree Strongly agree

31. My organization provides access to systems engineering training.
Mark only one box.

Strongly disagree Disagree Neutral Agree Strongly agree

32. Training provided by my organization has prepared me well for my systems engineering duties.
Mark only one box.

Strongly disagree Disagree Neutral Agree Strongly agree

33. My organization follows an established systems engineering model such as: Waterfall, V Model, Spiral, Agile, or Iterative.
Mark only one box.

Strongly disagree Disagree Neutral Agree Strongly agree

34. I have appropriate tools to successfully execute systems engineering in my organization.
Mark only one box.

Strongly disagree Disagree Neutral Agree Strongly agree

35. Appropriate training and guidance are provided for the systems engineering tools.
Mark only one box.

Strongly disagree Disagree Neutral Agree Strongly agree

36. The systems engineering tools provided are regularly used by my organization.
Mark only one box.

Strongly disagree Disagree Neutral Agree Strongly agree

37. My organization has employees whose sole responsibility is to facilitate the systems engineering process.
Mark only one box.

Strongly disagree Disagree Neutral Agree Strongly agree

38. My organization has the right people involved to successfully implement systems engineering.
Mark only one box.

Strongly disagree Disagree Neutral Agree Strongly agree

39. My organization has sufficient number of people to successfully implement systems engineering.
Mark only one box.

Strongly disagree Disagree Neutral Agree Strongly agree

40. There are performance measures or metrics used to evaluate the performance of systems engineering in my organization.
Mark only one box.

Strongly disagree Disagree Neutral Agree Strongly agree

41. Technical reviews are held at regular intervals to evaluate the performance of the systems engineering process. Such as system requirements reviews, preliminary design reviews, critical design reviews, etc.
Mark only one box.

Strongly disagree Disagree Neutral Agree Strongly agree

42. All stakeholders are informed of the project's progress.

Mark only one box.

Strongly disagree Disagree Neutral Agree Strongly agree

43. Resources allocated to a project are evaluated to determine if they are adequate to achieve project success.

Mark only one box.

Strongly disagree Disagree Neutral Agree Strongly agree

44. Applying a thorough systems engineering process in my organization reduces the number of launch vehicle manufacturing problems.

Mark only one box.

Strongly disagree Disagree Neutral Agree Strongly agree

45. Applying a thorough systems engineering process in my organization reduces the severity of launch vehicle manufacturing problems.

Mark only one box.

Strongly disagree Disagree Neutral Agree Strongly agree

46. Applying a thorough systems engineering process in my organization reduces the number of launch vehicle integration and test problems.

Mark only one box.

Strongly disagree Disagree Neutral Agree Strongly agree

47. Applying a thorough systems engineering process in my organization reduces the severity of launch vehicle integration and test problems.

Mark only one box.

Strongly disagree Disagree Neutral Agree Strongly agree

48. Applying a thorough systems engineering process in my organization reduces the number of launch vehicle problems during flight.

Mark only one box.

Strongly disagree Disagree Neutral Agree Strongly agree

49. Applying a thorough systems engineering process in my organization reduces the severity of launch vehicle problems during flight.

Mark only one box.

Strongly disagree Disagree Neutral Agree Strongly agree

APPENDIX B: IRB APPROVAL



University of Central Florida Institutional Review Board
 Office of Research & Commercialization
 12201 Research Parkway, Suite 501
 Orlando, Florida 32826-3246
 Telephone: 407-823-2901 or 407-882-2276
www.research.ucf.edu/compliance/irb.html

Determination of Exempt Human Research

From: UCF Institutional Review Board #1
 FWA00000351, IRB00001138
 To: Denton Gibson
 Date: May 30, 2018

Dear Researcher:

On 05/30/2018, the IRB reviewed the following activity as human participant research that is exempt from regulation:

Type of Review: Exempt Determination
 Project Title: Factors affecting Systems Engineering Rigor in Launch Vehicle Organizations
 Investigator: Denton Gibson
 IRB Number: SBE-18-14051
 Funding Agency:
 Grant Title:
 Research ID: N/A

This determination applies only to the activities described in the IRB submission and does not apply should any changes be made. If changes are made and there are questions about whether these changes affect the exempt status of the human research, please contact the IRB. When you have completed your research, please submit a Study Closure request in IRIS so that IRB records will be accurate.

In the conduct of this research, you are responsible to follow the requirements of the [Investigator Manual](#).

This letter is signed by:

Signature applied by Gillian Morien on 05/30/2018 09:31:21 AM EDT

Designated Reviewer

APPENDIX C: ASSUMPTIONS CHECK PLOTS

Normal P-P Plot of Regression Standardized Residual

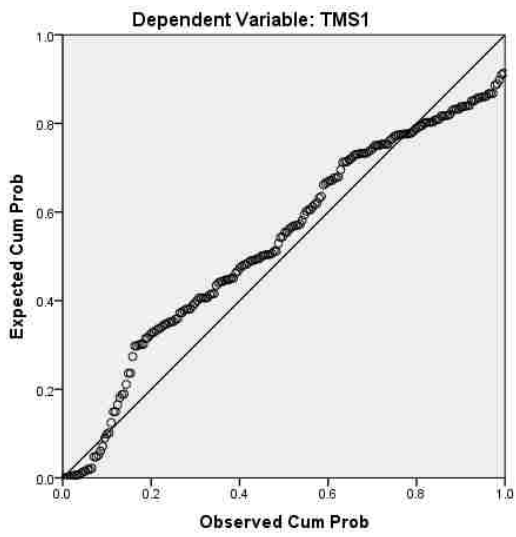

Scatterplot

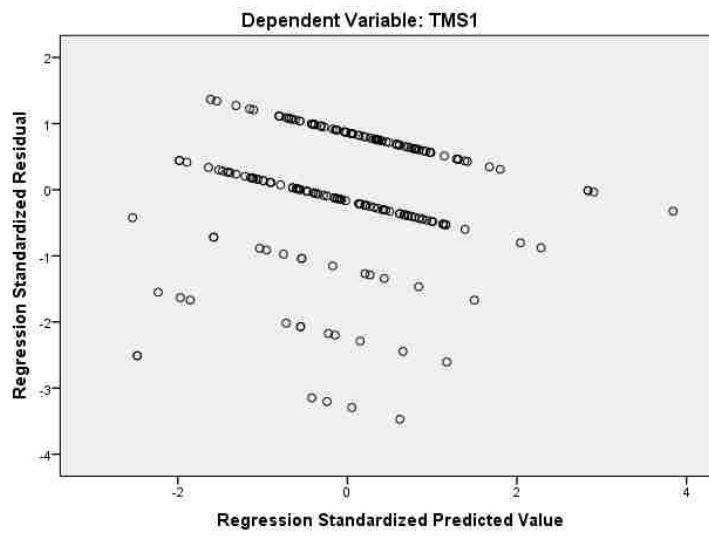

Normal P-P Plot of Regression Standardized Residual

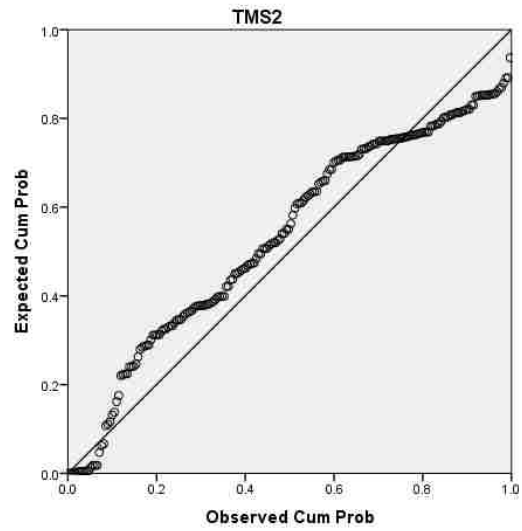

Scatterplot

Dependent Variable: TMS2

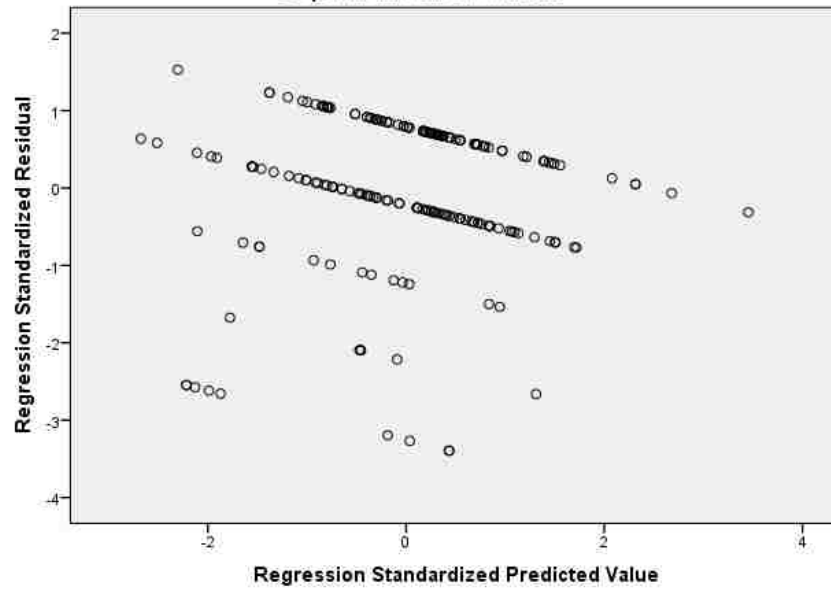

Normal P-P Plot of Regression Standardized Residual

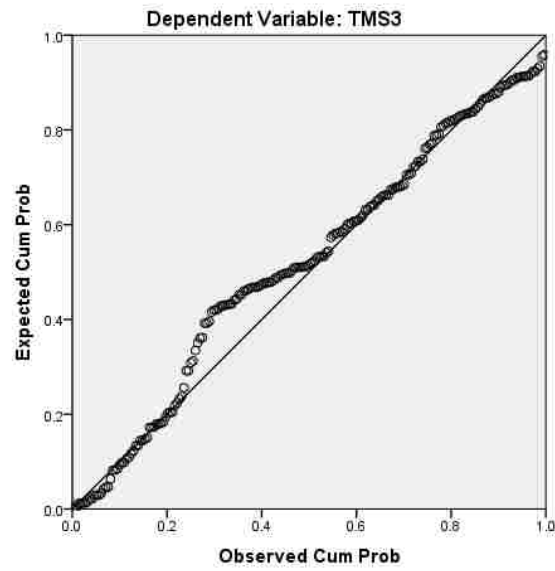

Scatterplot

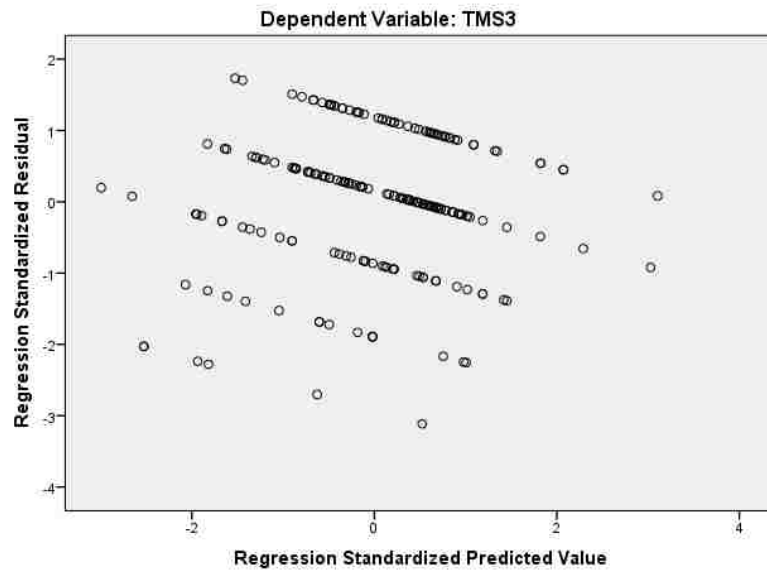

Normal P-P Plot of Regression Standardized Residual

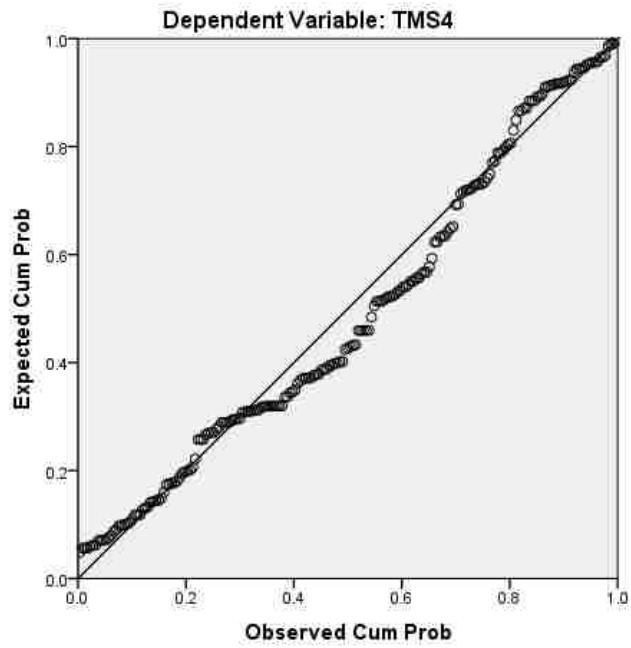

Scatterplot

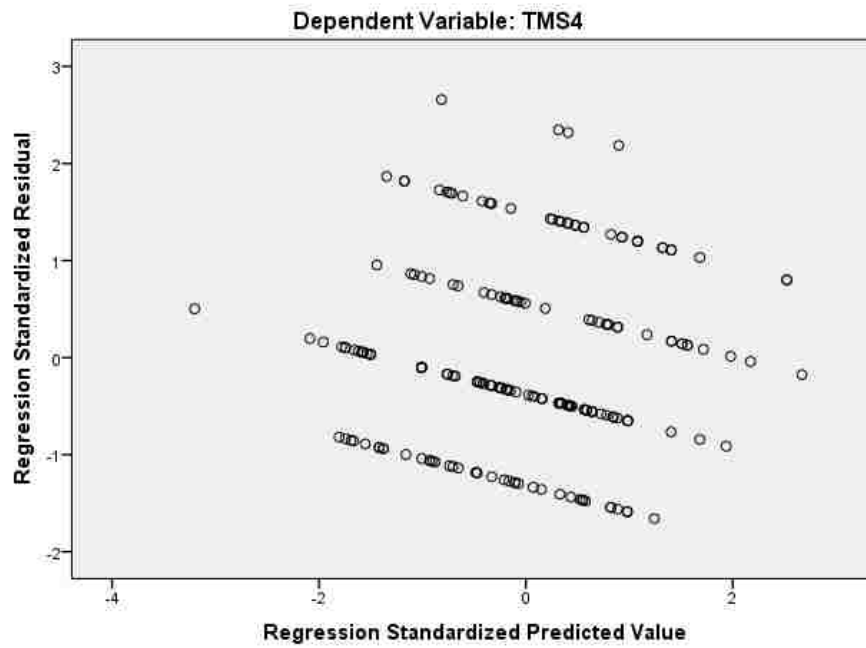

Normal P-P Plot of Regression Standardized Residual

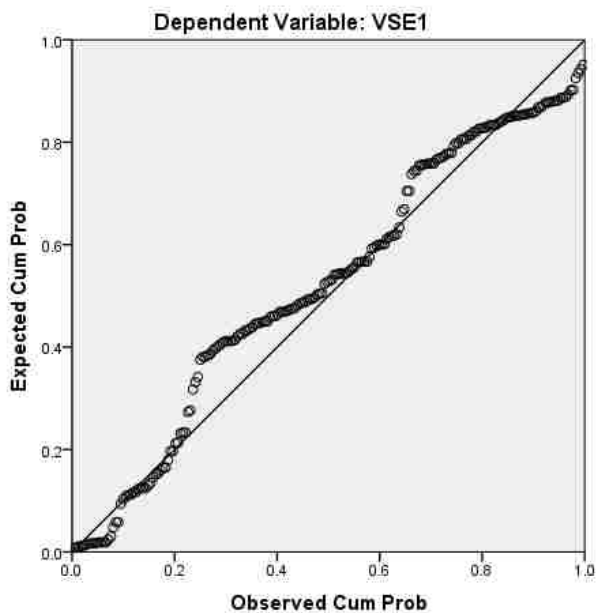

Scatterplot

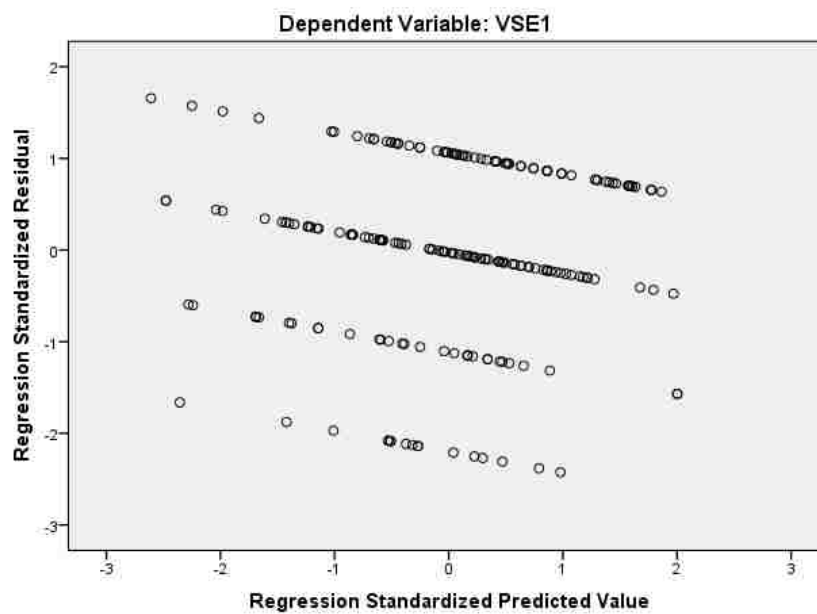

Normal P-P Plot of Regression Standardized Residual

Dependent Variable: Comm1

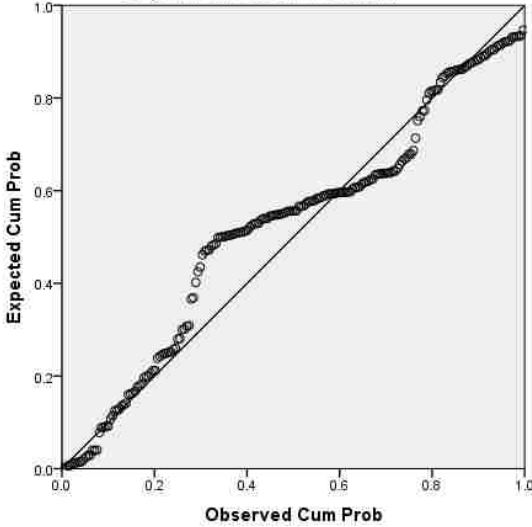

Scatterplot

Dependent Variable: Comm1

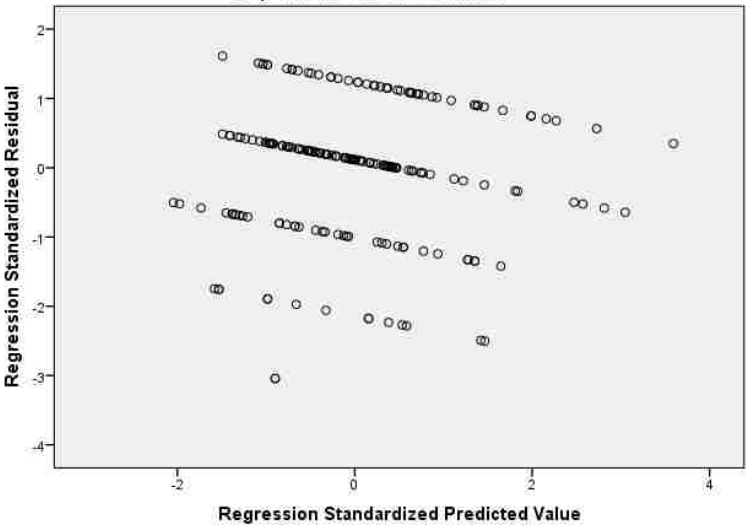

Normal P-P Plot of Regression Standardized Residual

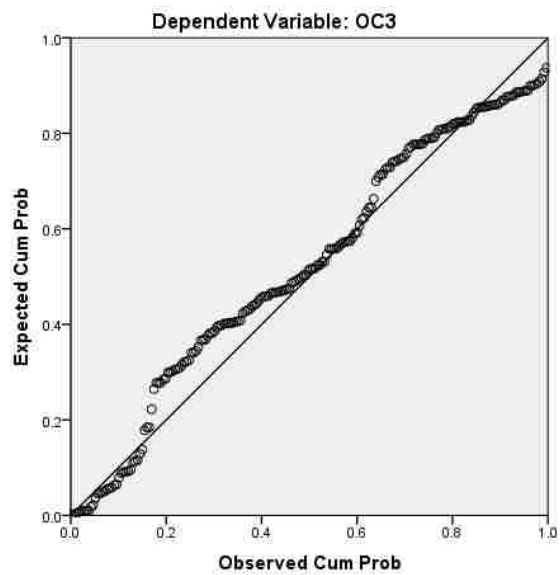

Scatterplot

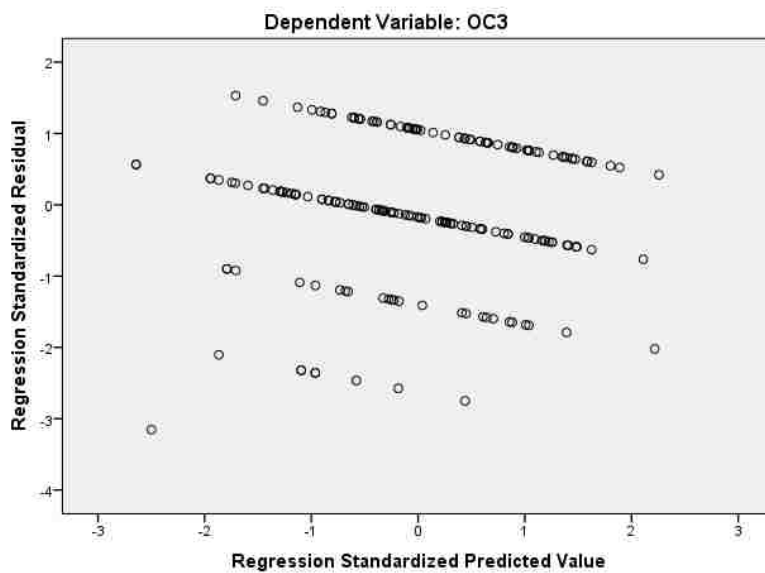

Normal P-P Plot of Regression Standardized Residual

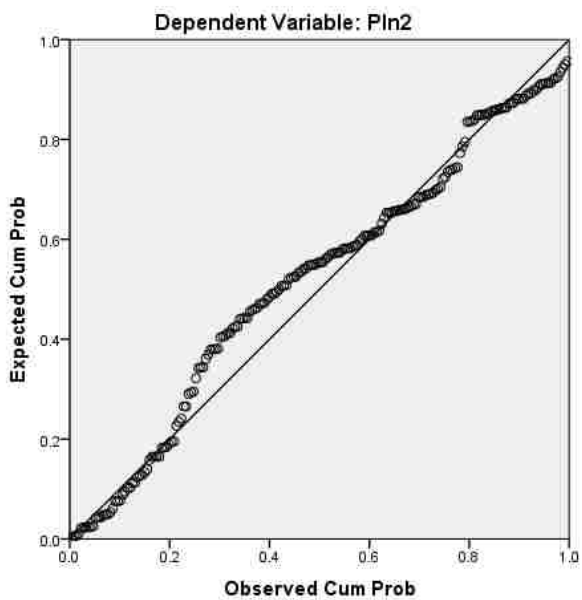

Scatterplot

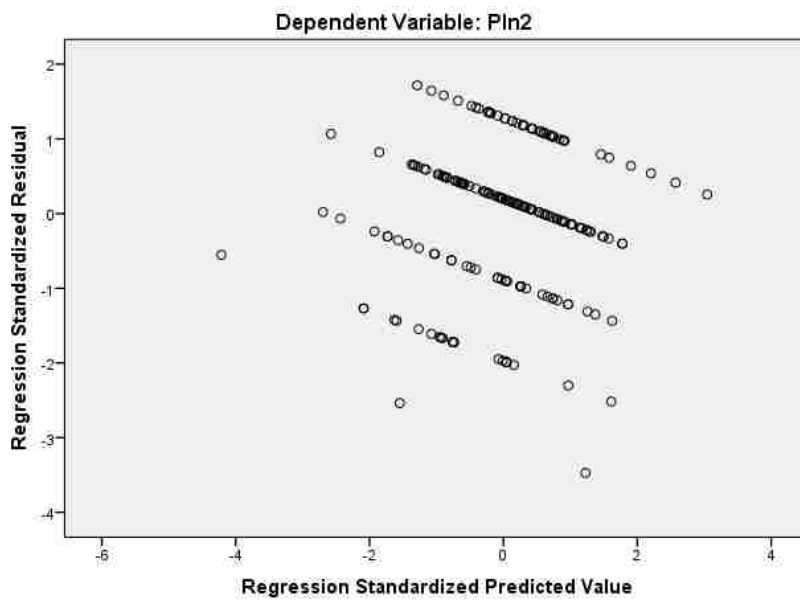

Normal P-P Plot of Regression Standardized Residual

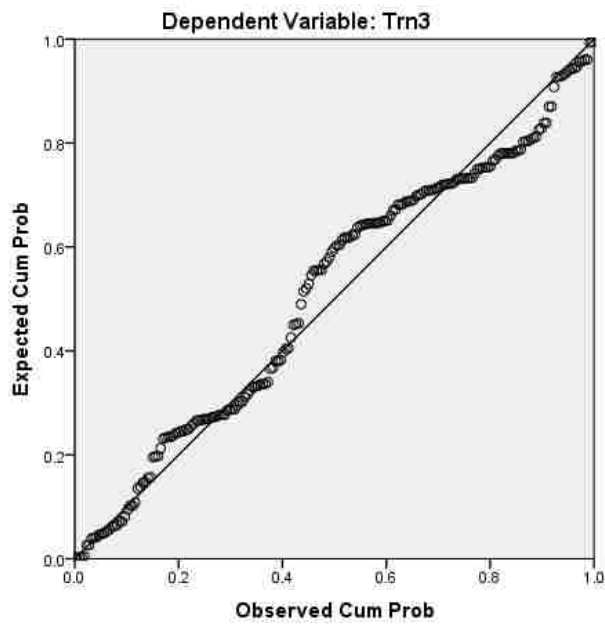

Scatterplot

Dependent Variable: Trn3

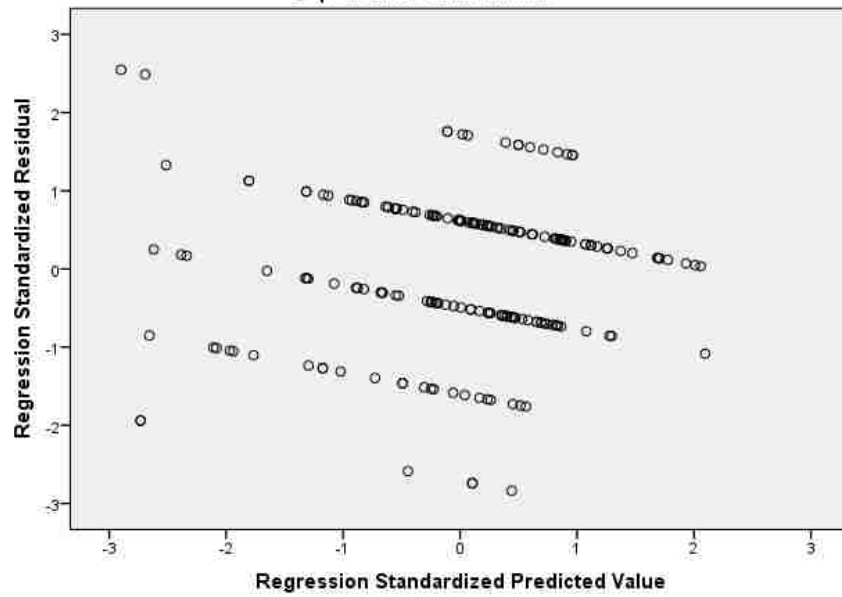

Normal P-P Plot of Regression Standardized Residual

Dependent Variable: Per2

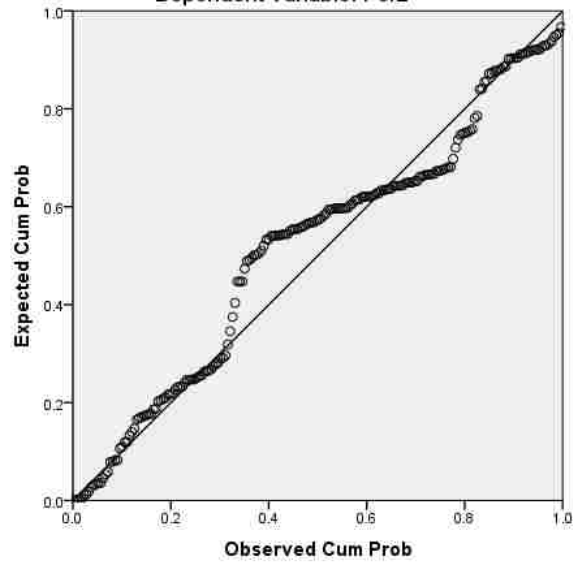

Scatterplot

Dependent Variable: Per2

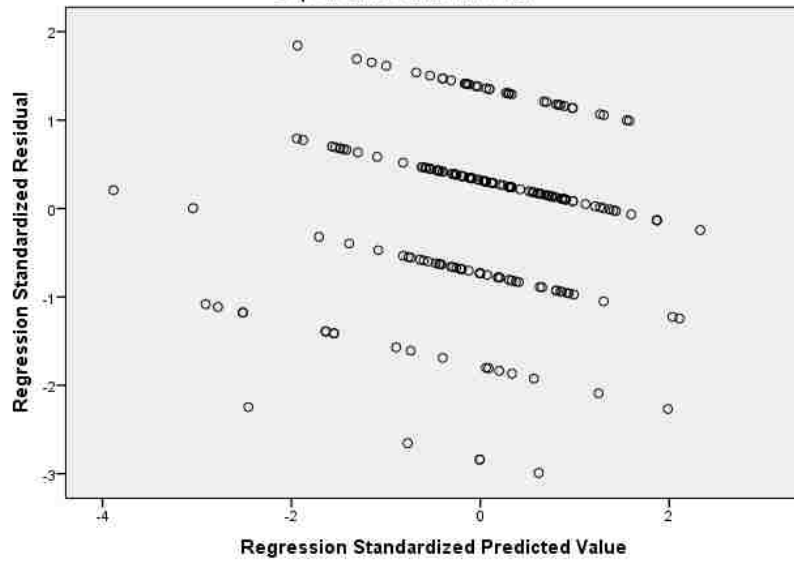

Normal P-P Plot of Regression Standardized Residual

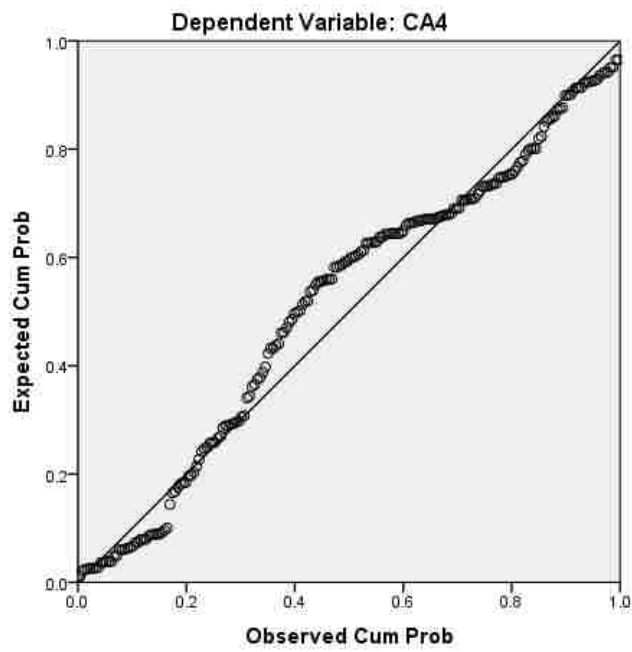

Scatterplot

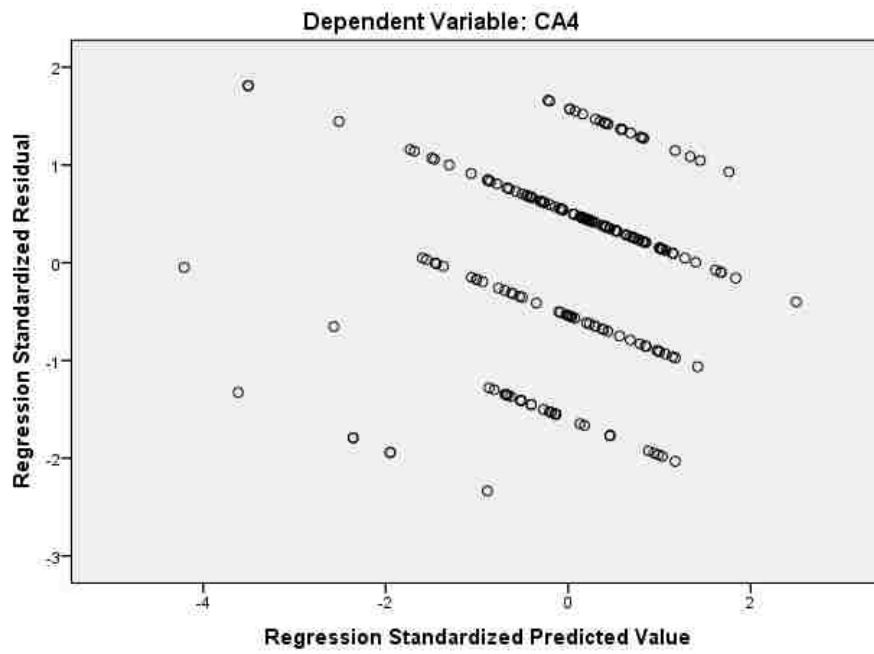

Normal P-P Plot of Regression Standardized Residual

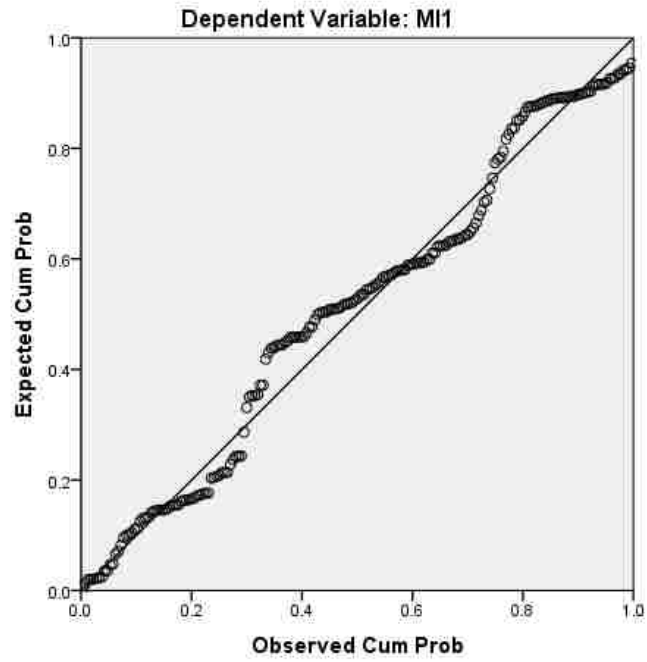

Scatterplot

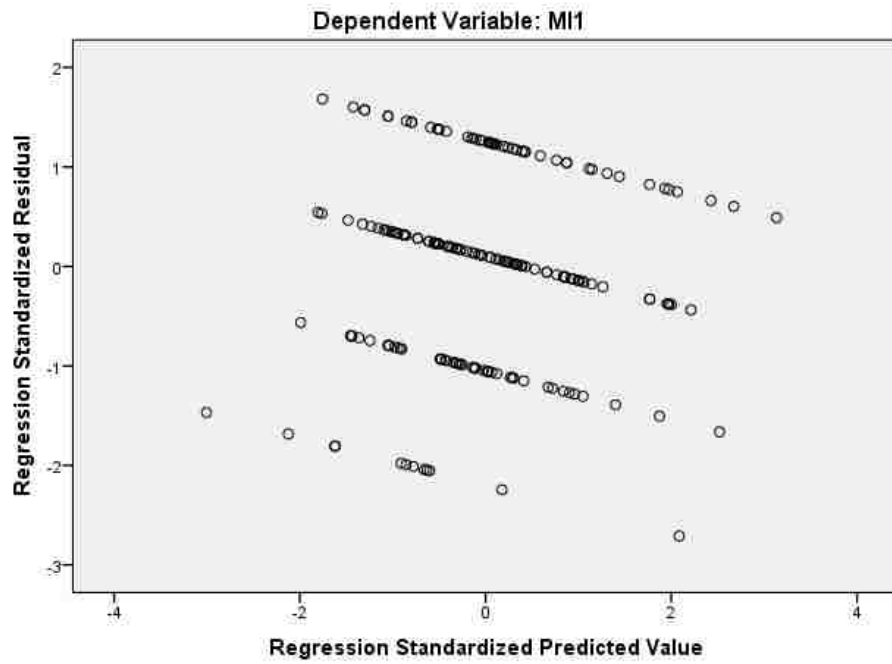

Normal P-P Plot of Regression Standardized Residual
Dependent Variable: ITI2

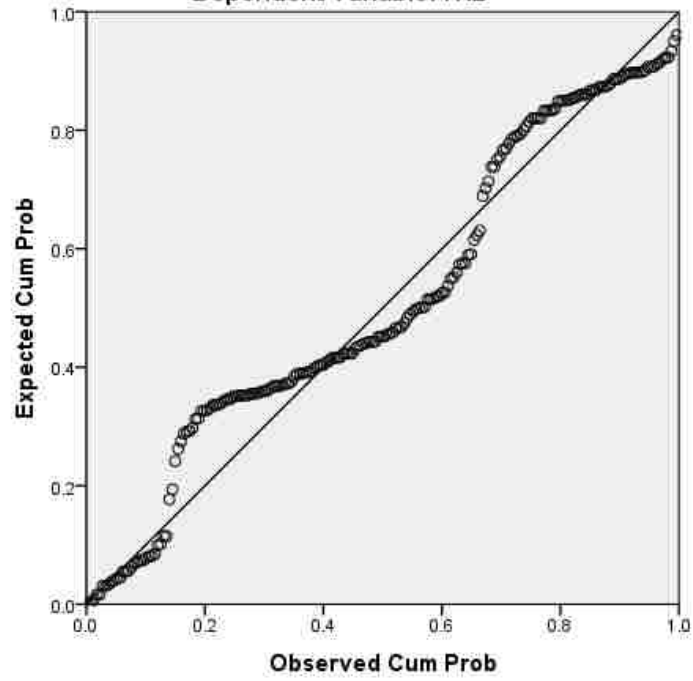

Scatterplot
Dependent Variable: ITI2

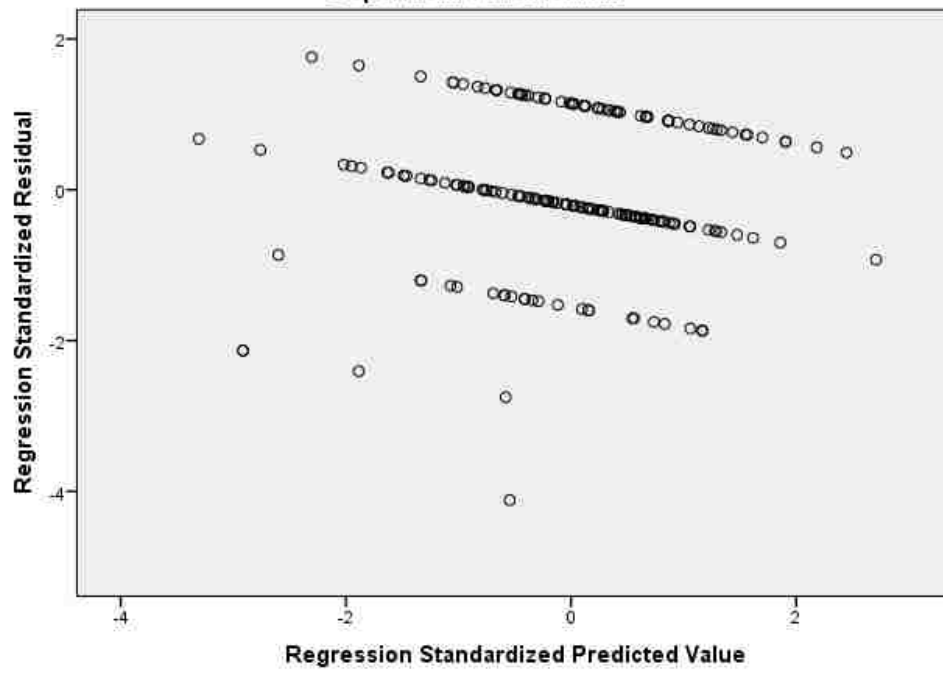

Normal P-P Plot of Regression Standardized Residual

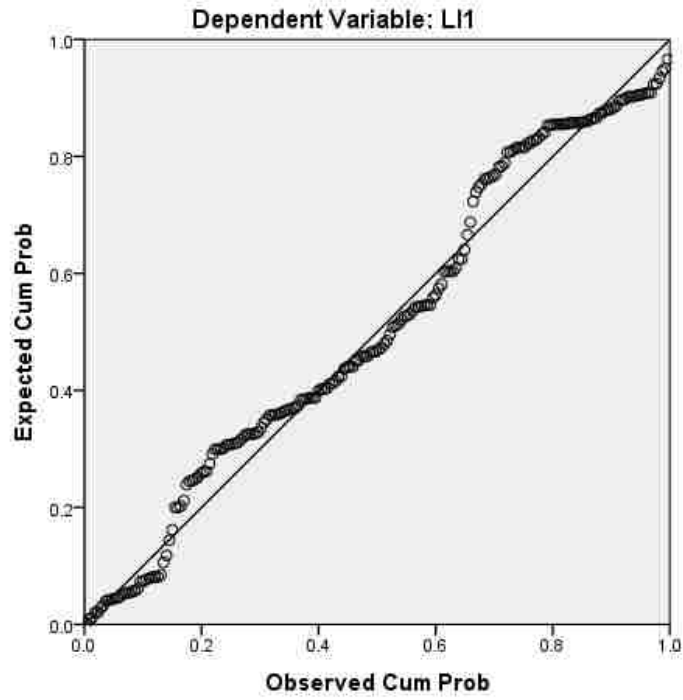

Scatterplot

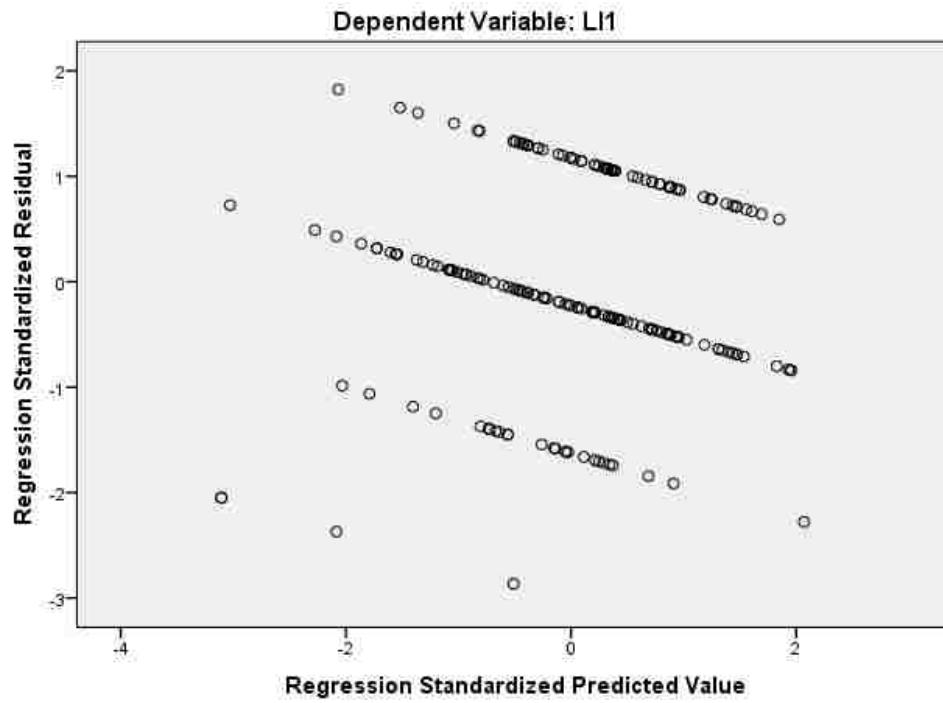

Correlations: Top Management Support

		TMS1	TMS2	TMS3	TMS4	TMS5
TMS1	Pearson Correlation	1	.867**	.711**	-.435**	-.343**
	Sig. (2-tailed)		.000	.000	.000	.000
	N	207	207	207	206	206
TMS2	Pearson Correlation	.867**	1	.685**	-.459**	-.385**
	Sig. (2-tailed)	.000		.000	.000	.000
	N	207	207	207	206	206
TMS3	Pearson Correlation	.711**	.685**	1	-.433**	-.416**
	Sig. (2-tailed)	.000	.000		.000	.000
	N	207	207	207	206	206
TMS4	Pearson Correlation	-.435**	-.459**	-.433**	1	.806**
	Sig. (2-tailed)	.000	.000	.000		.000
	N	206	206	206	206	205
TMS5	Pearson Correlation	-.343**	-.385**	-.416**	.806**	1
	Sig. (2-tailed)	.000	.000	.000	.000	
	N	206	206	206	205	206

** . Correlation is significant at the 0.01 level (2-tailed).

Correlations: Value of Systems Engineering

		VSE1	VSE2	VSE3
VSE1	Pearson Correlation	1	.646**	.526**
	Sig. (2-tailed)		.000	.000
	N	207	206	206
VSE2	Pearson Correlation	.646**	1	.440**
	Sig. (2-tailed)	.000		.000
	N	206	206	205
VSE3	Pearson Correlation	.526**	.440**	1
	Sig. (2-tailed)	.000	.000	
	N	206	205	206

** . Correlation is significant at the 0.01 level (2-tailed).

Correlations: Communication

		Comm1	Comm2	Comm3	Comm4	Comm5
Comm1	Pearson Correlation	1	.614**	.420**	.296**	.348**
	Sig. (2-tailed)		.000	.000	.000	.000
	N	207	206	207	207	207
Comm2	Pearson Correlation	.614**	1	.436**	.321**	.426**
	Sig. (2-tailed)	.000		.000	.000	.000
	N	206	206	206	206	206
Comm3	Pearson Correlation	.420**	.436**	1	.570**	.436**
	Sig. (2-tailed)	.000	.000		.000	.000
	N	207	206	207	207	207
Comm4	Pearson Correlation	.296**	.321**	.570**	1	.441**
	Sig. (2-tailed)	.000	.000	.000		.000
	N	207	206	207	207	207
Comm5	Pearson Correlation	.348**	.426**	.436**	.441**	1
	Sig. (2-tailed)	.000	.000	.000	.000	
	N	207	206	207	207	207

** . Correlation is significant at the 0.01 level (2-tailed).

Correlations: Organizational Commitment

		OC1	OC2	OC3	OC4	OC5	OC6
OC1	Pearson Correlation	1	.417**	.305**	.408**	.416**	.343**
	Sig. (2-tailed)		.000	.000	.000	.000	.000
	N	205	205	204	204	203	200
OC2	Pearson Correlation	.417**	1	.630**	.776**	.623**	.659**
	Sig. (2-tailed)	.000		.000	.000	.000	.000
	N	205	205	204	204	203	200
OC3	Pearson Correlation	.305**	.630**	1	.619**	.470**	.599**
	Sig. (2-tailed)	.000	.000		.000	.000	.000
	N	204	204	204	203	203	199
OC4	Pearson Correlation	.408**	.776**	.619**	1	.736**	.596**
	Sig. (2-tailed)	.000	.000	.000		.000	.000
	N	204	204	203	204	202	199
OC5	Pearson Correlation	.416**	.623**	.470**	.736**	1	.472**
	Sig. (2-tailed)	.000	.000	.000	.000		.000
	N	203	203	203	202	203	198
OC6	Pearson Correlation	.343**	.659**	.599**	.596**	.472**	1
	Sig. (2-tailed)	.000	.000	.000	.000	.000	
	N	200	200	199	199	198	200

** . Correlation is significant at the 0.01 level (2-tailed).

Correlations: Planning

		Pln1	Pln2	Pln3	Pln4
Pln1	Pearson Correlation	1	.473**	.259**	.458**
	Sig. (2-tailed)		.000	.000	.000
	N	204	204	204	198
Pln2	Pearson Correlation	.473**	1	.473**	.334**
	Sig. (2-tailed)	.000		.000	.000
	N	204	205	205	199
Pln3	Pearson Correlation	.259**	.473**	1	.380**
	Sig. (2-tailed)	.000	.000		.000
	N	204	205	205	199
Pln4	Pearson Correlation	.458**	.334**	.380**	1
	Sig. (2-tailed)	.000	.000	.000	
	N	198	199	199	199

** . Correlation is significant at the 0.01 level (2-tailed).

Correlations: Training

		Trn1	Trn2	Trn3
Trn1	Pearson Correlation	1	.461**	.363**
	Sig. (2-tailed)		.000	.000
	N	204	204	203
Trn2	Pearson Correlation	.461**	1	.631**
	Sig. (2-tailed)	.000		.000
	N	204	205	204
Trn3	Pearson Correlation	.363**	.631**	1
	Sig. (2-tailed)	.000	.000	
	N	203	204	204

** . Correlation is significant at the 0.01 level (2-tailed).

Correlations: Tools and Infrastructure

		TI1	TI2	TI3	TI4
TI1	Pearson Correlation	1	.440**	.412**	.402**
	Sig. (2-tailed)		.000	.000	.000
	N	205	205	204	202
TI2	Pearson Correlation	.440**	1	.684**	.618**
	Sig. (2-tailed)	.000		.000	.000
	N	205	205	204	202
TI3	Pearson Correlation	.412**	.684**	1	.522**
	Sig. (2-tailed)	.000	.000		.000
	N	204	204	204	201
TI4	Pearson Correlation	.402**	.618**	.522**	1
	Sig. (2-tailed)	.000	.000	.000	
	N	202	202	201	204

** . Correlation is significant at the 0.01 level (2-tailed).

Correlations: Personnel

		Per1	Per2	Per3
Per1	Pearson Correlation	1	.492**	.450**
	Sig. (2-tailed)		.000	.000
	N	205	205	204
Per2	Pearson Correlation	.492**	1	.616**
	Sig. (2-tailed)	.000		.000
	N	205	205	204
Per3	Pearson Correlation	.450**	.616**	1
	Sig. (2-tailed)	.000	.000	
	N	204	204	204

** . Correlation is significant at the 0.01 level (2-tailed).

Correlations: Control and Assessment

		CA1	CA2	CA3	CA4
CA1	Pearson Correlation	1	.390**	.363**	.361**
	Sig. (2-tailed)		.000	.000	.000
	N	204	204	204	204
CA2	Pearson Correlation	.390**	1	.429**	.406**
	Sig. (2-tailed)	.000		.000	.000
	N	204	205	205	205
CA3	Pearson Correlation	.363**	.429**	1	.492**
	Sig. (2-tailed)	.000	.000		.000
	N	204	205	205	205
CA4	Pearson Correlation	.361**	.406**	.492**	1
	Sig. (2-tailed)	.000	.000	.000	
	N	204	205	205	205

** . Correlation is significant at the 0.01 level (2-tailed).

Correlations: Manufacturing Issues

		MI1	MI2
MI1	Pearson Correlation	1	.830**
	Sig. (2-tailed)		.000
	N	203	203
MI2	Pearson Correlation	.830**	1
	Sig. (2-tailed)	.000	
	N	203	204

** . Correlation is significant at the 0.01 level (2-tailed).

Correlations: Integration & Test Issues

		IT1	IT2
IT1	Pearson Correlation	1	.836**
	Sig. (2-tailed)		.000
	N	205	205
IT2	Pearson Correlation	.836**	1
	Sig. (2-tailed)	.000	
	N	205	205

** . Correlation is significant at the 0.01 level (2-tailed).

Correlations: Launch Issues

		LI1	LI2
LI1	Pearson Correlation	1	.886**
	Sig. (2-tailed)		.000
	N	205	205
LI2	Pearson Correlation	.886**	1
	Sig. (2-tailed)	.000	
	N	205	205

** . Correlation is significant at the 0.01 level (2-tailed).

Correlation Matrix for SE Culture Model

	TMS1	TMS2	TMS3	TMS4	Comm1	Comm2	Comm3	Comm4	Comm5	OC1	OC2	OC4	OC5	Org Size
TMS1	1													
TMS2	0.870	1												
TMS3	0.719	0.705	1											
TMS4	0.438	0.455	0.446	1										
Comm1	0.226	0.187	0.265	0.176	1									
Comm2	0.140	0.147	0.224	0.226	0.583	1								
Comm3	0.399	0.391	0.380	0.393	0.364	0.400	1							
Comm4	0.503	0.454	0.541	0.361	0.287	0.326	0.570	1						
Comm5	0.401	0.397	0.330	0.392	0.261	0.374	0.376	0.441	1					
OC1	0.085	0.108	0.143	0.144	0.217	0.287	0.350	0.205	0.354	1				
OC2	0.202	0.152	0.273	0.234	0.284	0.258	0.388	0.332	0.359	0.457	1			
OC4	0.233	0.195	0.261	0.207	0.293	0.265	0.450	0.300	0.311	0.418	0.787	1		
OC5	0.267	0.261	0.235	0.207	0.246	0.142	0.379	0.286	0.241	0.411	0.660	0.740	1	
Org Size	0.099	0.114	0.106	0.124	0.071	0.025	0.178	0.158	0.066	0.060	0.105	0.058	0.043	1

REFERENCES

- Abrahamsson, P. (2000). *Is Management Commitment a Necessity After All in Software Process Improvement?* Paper presented at the The 26th Euromicro Conference, Maastricht, Netherlands.
- Alnoaimi, M. (2015). *Safety Climate and Safety Outcomes in Aircraft Maintenance: A Mediating Effect of Employee Turnover and Safety Motivation*. (Doctor of Philosophy), University of Central Florida, Orlando, Florida.
- Alsowayigh, M. (2014). *Assessing safety culture among pilots in Saudi Airlines: Quantitative Study Approach*. (Doctor of Philosophy), University of Central Florida, Orlando, FL.
- Appelbaum, L., & Paese, M. (2002). *What Senior Leaders Do: The Nine Roles of Strategic Leadership*. Retrieved from
- Balaji, S., & Murugaiyan, M. S. (2012). Waterfall Vs V-Model Vs Agile: A comparative Study on SDLC. *International Journal of Information Technology and Business Management*, 2(1).
- Baruch, Y., & Holtom, B. C. (2008). Survey response rate levels and trends in organizational research. *Human Relations*, 61(8), 1139-1160. doi:10.1177/0018726708094863
- Beck, K., Beedle, M., Bennekum, A. v., Cockburn, A., Cunningham, W., Fowler, M., . . . Thomas, D. (2001). Manifesto for Agile Software Development. Retrieved from <http://www.agilemanifesto.org/>
- Becker, H. S. (1958). Problems of Influence and Proof in Participant Observation. *American Sociological Review*, 23(6), 652-660.
- Belassi, W., & Tukel, O. I. (1996). A new framework for determining critical success failure factors in projects 1996. *International Journal of Project Management*, 14, 141-151.
- Berente, N., Ivanov, D., & Vandenbosch, B. (2007). *Process Compliance and Enterprise System Implementation*. Paper presented at the 40th Annual Hawaii International Conference on System Sciences, Waikoloa, HI.
- Bijan, Y., Yu, J., Stracener, J., & Woods, T. (2013). Systems Requirements Engineering - State of the Methodology. *Systems Engineering*, 16(3), 267-276. doi:10.1002/sys.21227
- 10.1002/sys
- Bjorkman, E. A., Harkani, S., & Mazzuchi, T. A. (2012). Using Model-Based Systems Engineering as a Framework for Improving Test and Evaluation Activities. *Systems Engineering*, 16(3), 346-362. doi:10.1002/sys.21241
- Bjorn, B. (2012). *Critical Success Factors for Evolutionary Acquisition Implementation*. (Doctor of Philosophy), University of Central Florida.
- BKCASE Editorial Board. (2014). Guide to the Systems Engineering Body of Knowledge. 1.7.
- Blair, J. C., Ryan, R. S., & Schutzenhofer, L. A. (2011). Lessons Learned in Engineering.

- Boomsma, A., & Hoogland, J. J. (2001). The Robustness of LISREL Modeling Revisited. In L. Stam (Ed.), *Structural Equation Modeling: Present and Future : a Festschrift in Honor of Karl Joreskog*. Lincolnwood, IL: Scientific Software International, Inc.
- Brill, J. (1999). Systems Engineering - A Restrospective View. *Systems Engineering*, 1(4), 258-266.
- Brown, D. C. (1998). *PACTS 21 - defining the systems engineering process, tools and metrics for IMA systems development*. Retrieved from London, England:
- Brown, T. A. (2006). *Confirmatory Factor Analysis for Applied Research*. New York: The Guilford Press.
- Bruff, R. S. (2008). *Systems engineering best practices as measures for successful outcomes in selected United States defense industry aerospace programs*. (3332699 Ph.D.), Walden University, Ann Arbor. Retrieved from <https://login.ezproxy.net.ucf.edu/login?url=http://search.proquest.com/docview/304934893?accountid=10003>
- http://sfx.fcla.edu/ucf?url_ver=Z39.88-2004&rft_val_fmt=info:ofi/fmt:kev:mtx:dissertation&genre=dissertations+%26+theses&sid=ProQ:ProQuest+Dissertations+%26+Theses+A%26I&atitle=&title=Systems+engineering+best+practices+as+measures+for+successful+outcomes+in+selected+United+State+s+defense+industry+aerospace+programs&issn=&date=2006-01-01&volume=&issue=&spage=&au=Bruff%2C+Robert+S.&isbn=9780549836216&jtitle=&bttitle=&rft_id=info:eric/&rft_id=info:doi/ ProQuest Dissertations & Theses A&I; ProQuest Dissertations & Theses Global database.
- Burnard, P. (1991). A method of analysing interview transcripts in qualitative research. *Nurse Education Today*, 11, 461-466.
- Byrne, B. M. (2016). *Structural Equation Modeling with Amos* (3rd ed.). Ney York: Routledge.
- Carroll, E. (2016). *Systems Engineering Cultural Transformation*. Paper presented at the Socorro Systems Summit, Socorro, NM.
- Carson, R. S., & Zlicaric, B. (2008). *Using Performance-Based Earned Value for Measuring Systems Engineering Effectiveness*. Paper presented at the INCOSE 2008: 18th Annual International Council on Systems Engineering, Netherlands.
- Centre, S. S. (2001). *Approches to the Analysis of Survey Data*. Retrieved from Reading, UK:
- Chang, I. S. (1996). Investigation of space launch vehicle catastrophic failures. *Journal of Spacecraft and Rockets*, 33(2), 198-205.
- Chatman, J. A., & O'Reilly, C. A. (2016). Paradigm lost: Reinvigorating the study of organizational culture. *Research in Organizational Behavior*, 36, 199-224. doi:10.1016/j.riob.2016.11.004

- Chenail, R. J. (2011). Interviewing the investigator: Strategies for addressing instrumentation and researcher bias concerns in qualitative research. *The Qualitative Report*, 16(1), 255-262.
- Chou, J. S., & Ngo, N. T. (2014, 9-12 Dec. 2014). *Identifying critical project management techniques and skills for construction professionals to achieving project success*. Paper presented at the 2014 IEEE International Conference on Industrial Engineering and Engineering Management.
- Componation, P. J., Utley, D. R., Farrington, P. A., & Youngblood, A. D. (2009). Assessing the Relationships between Project Success and Systems Engineering Processes at NASA. *IIE Annual Conference. Proceedings*, 456-461.
- Consolidated Appropriations Act 2018, United States Congress, Pub. L. No. 115-141 (2018 03/23/2018).
- Creswell, J. W. (2014). *Research Design: Qualitative, Quantitative, and Mixed Methods Approaches* (4th ed.). Los Angeles: SAGE Publications.
- Czaja, A., Dumitrescu, R., & Anacker, H. (2016, 3-5 Oct. 2016). *Target-oriented implementation of systems engineering in medium-sized enterprises: Project example for mbse implementation in mechanical and plant engineering*. Paper presented at the 2016 IEEE International Symposium on Systems Engineering (ISSE).
- Dean, F. F., Bentz, B., & Bahill, A. T. (1997). *A Road Map for Implementing Systems Engineering*. Retrieved from Albuquerque, NM:
- Deegan, J. (1978). On the Occurrence of Standardize Regrsssion Coefficients Greater Than One. *Educational & Psychological Measurement*, 38(4), 873-888.
- EIA. (1999). Processes for Engineering a System.
- Elm, J. P. (2012). Developing a Business Case for Systems Engineering. *IEEE Aerospace and Electronic Systems Magazine*, 27(7), 13-19.
- Elm, J. P., & Goldenson, D. R. (2012). The Business Case for Systems Engineering Study - Results of Effectiveness Survey.
- Elm, J. P., Goldenson, D. R., Emam, K. E., Donatelli, N., Neisa, A., & Committee, N. S. E. (2008). A Survey of Systesms Engineering Effectiveness.
- Emes, M., Smith, A., & Cowper, D. (2005). Confronting an Identity Crisis—How To “Brand” Systems Engineering. *Systems Engineering*, 8(2), 164-186. doi:10.1002/sys.20028
- Emes, M. R., Bryant, P. A., Wilkinson, M. K., King, P., James, A. M., & Arnold, S. (2012). Interpreting “Systems Architecting”. *Systems Engineering*, 15(4), 369-395. doi:10.1002/sys.21202
- 10.1002/sys
- Evans, J. R., & Lindsay, W. M. (2014). *Managing for Quality and Performance Excellence* (9th ed.). Mason, OH: South-Western, Cengage Learning.

- Fabrigar, L. R., & Wegener, D. T. (2011). *Exploratory Factor Analysis*. New York: Oxford.
- Fleming, Q. W., & Koppelman, J. M. (2005). *Earned Value Project Management* (3rd ed.). Newton Square, PA: Project Management Institute.
- Fogarty, G. J. (2004). The Role of Organizational and Individual Variables in Aircraft Maintenance Performance. *International Journal of Applied Aviation Studies*, 4(3), 73-90.
- Fortune, J., & White, D. (2006). Framing of project critical success factors by a systems model. *International Journal of Project Management*, 24(1), 53-65.
doi:10.1016/j.ijproman.2005.07.004
- Frey, T. M., & Valencia, M. C. (2010). Enhancing Systems Engineering Agility with Modeling and Simulation. *John Hopkins APL Technical Digest*, 29(2), 186-196.
- Gambi, L. D. N., Boer, H., Gerolamo, M. C., Jørgensen, F., & Carpinetti, L. C. R. (2015). The relationship between organizational culture and quality techniques, and its impact on operational performance. *International Journal of Operations & Production Management*, 35(10), 1460-1484. doi:10.1108/ijopm-12-2013-0563
- Gibbons, A. M., von Thaden, T. L., & Wiegmann, D. A. (2006). Development and Initial Validation of a Survey for Assessing Safety Culture Within Commercial Flight Operations. *International Journal of Aviation Psychology*, 16(2), 215-238.
doi:10.1207/s15327108ijap1602_6
- Gibson, D. (2019). Launch vehicle systems engineering life-cycle evolution and comparison. *Systems Engineering*. doi:10.1002/sys.21485
- Gilb, T. (2008). Making Metrics More Practical in Systems Engineering: INCOSE.
- Gill, P. S., Garcia, D., & Vaughan, W. W. (2005). *Engineering Lessons Learned and Systems Engineering Applications*. Paper presented at the 43rd AIAA Aerospace Sciences Meeting and Exhibit, Reno, Nevada.
- Goldberg, D. E. (2009). Engineering Rigor and Its Discontents *Philosophical Reflection as Curative to Math-Physics Envy*. Urbana, IL: Illinois Foundry for Innovation in Engineering Education.
- Gruhl, W. (1992). *Lessons Learned, Cost/Schedule Assessment Guide*. Retrieved from Washington, D.C.:
- Gydesen, P. W. (2006). *What is the impact to national security without commercial space applications*. Air University, Maxwell Air Force Base, Alabama
- Hair, J. F., Black, W. C., Babin, B. J., & Anderson, R. E. (2014). *Multivariate Data Analysis* (7th ed.). England: Pearson.
- Harland, D. M., & Lorenz, R. D. (2005). *Space Systems Failures*. Chichester, UK: Springer-Praxis.

- Head, S., & Virostko, B. (2009). Systems Engineering Execution and Knowledge Management. *IEEE Aerospace and Electronic Systems Magazine*, 24(10), 4-9.
- Hogan, S. J., & Coote, L. V. (2014). Organizational culture, innovation, and performance: A test of Schein's model. *Journal of Business Research*, 67(8), 1609-1621.
doi:10.1016/j.jbusres.2013.09.007
- Honour, E. C. (2004). Understanding the Value of Systems Engineering. *INCOSE*.
- Honour, E. C. (2010). *Systems Engineering Return on Investment*. Paper presented at the 20th annual International Symposium of the International Council on Systems Engineering Chicago, IL.
- Honour, E. C., Axelband, E., & Rhodes, D. H. (2004). *Value of Systems Engineering*. Retrieved from
- Honour, E. C., & Valerdi, R. (2006). Advancing an ontology for systems engineering to allow consistent measurement.
- Hout, T. M., & Carter, J. C. (1995). Getting it Done: New Roles for Senior Executives. *Harvard Business Review*, 73(6), 133-144.
- Hoyle, R. (Ed.) (2012). *Handbook of Structural Equation Modeling*. New York: The Guilford Press.
- Hsu, J., Raghunathan, S., & Curran, R. (2008). Effective Learning in Systems Engineering.
doi:10.2514/6.2008-1117
- Huang, P. M., Knuth, A. A., Kreuger, R. O., & Garrison-Darrin, M. A. (2012). *Agile Hardware and Software Systems Engineering for Critical Military Space Applications*. Paper presented at the Proceedings of SPIE, The International Society of Optical Engineering.
- IEEE. (2008). Systems and software engineering - System Life Cycle Processes: ISO.
- Iivari, J., & Huisman, M. (2007). The Relationship between Organizational Culture and the Deployment of Systems Development Methodologies. *MIS Quarterly*, 31(1), 35-58.
- INCOSE. (2007). *Systems Engineering Vision 2020*. Retrieved from
- INCOSE. (2010). *Systems Engineering Measurement Primer*.
- INCOSE. (2011). *Systems Engineering Handbook*: INCOSE.
- Isakowitz, S. J., Hopkins, J. B., & Jr., J. P. H. (2004). *International Reference Guide to Space Launch Systems*. Reston, VA: American Institute of Aeronautics and Astronautics.
- ISO. (2007). ISO/IEC Standard for Systems Engineering - Application and Management of the Systems Engineering Process *ISO/IEC 26702 IEEE Std 1220-2005 First edition 2007-07-15* (pp. c1-88).
- ISO. (2008). *System Engineering - Guideline for the Application of ISO 9001 to System Life Cycle Processes*. Switzerland: ISO.

- ISO/IEC. (2007). ISO/IEC 15939:2007 Systems and Software Engineering Measurement Process *ISO/IEC 15939:2007* (pp. C1-40).
- Jansma, P. A. (2010). Making a case for systems engineering. *IEEE Aerospace and Electronic Systems Magazine*, 25(4), 4-17.
- Joreskog, K. G. (1999). How Large Can a Standardized Coefficient Be?
- Kahkonen, T. (2004). *Agile Methods for Large Organizations - Building communities of Practice*. Paper presented at the Agile Development Conference, Salt Lake City, UT.
- Kaskowitz, R. (1990). *Lessons Learned from Selecting and Implementing Advanced Systems Engineering Methods and Tools in an Integrated Computerized Environment*. Paper presented at the The Second IFIP WG 10.2 Workshop on Electronic Design Automation Frameworks, Charlottesville, VA.
- Kitchenham, B., & Pfleeger, S. L. (2003). Principles of Survey Research Part 6: Data Analysis. *Software Engineering Notes*, 28(2), 24-27.
- Kitterman, D. (2005). *A Structured Method for Generating, Evaluating and Using Metrics*. Paper presented at the INCOSE 2005 Rochester, NY.
- Kline, R. (2011). *Principles and Practices of Structural Equation Modeling* (3rd ed.). New York: The Guilford Press.
- Kludze, A.-K. K. P. (2004). *Engineering of complex systems: The impact of systems engineering at NASA*. (3144615 D.Sc.), The George Washington University, Ann Arbor. ProQuest Dissertations & Theses Full Text database.
- Landis, R. S., Beal, D. J., & Tesluk, P. E. (2000). A Comparison of Approaches to Forming Composite Measures in Structural Equation Models. *Organizational Research Methods*, 3(2), 186-207. doi:10.1177/109442810032003
- Leedy, P. D., & Ormrod, J. E. (2013). *Practical Research* (10 ed.). Upper Saddle River, New Jersey: Pearson.
- Leung, R. (2014). *The Effect of Mission Assurance on ELV Launch Success Rate: An Analysis of Two Management Systems for Launch Vehicles*. (Doctor of Philosophy), The George Washington University, Ann Arbor, MI.
- MacCallum, R. C., Widaman, K. F., Preacher, K. J., & Hong, S. (2001). Sample Size in Factor Analysis: The Role of Model Error. *Multivariate Behavioral Research*, 36(4), 611-637.
- MacCallum, R. C., Widaman, K. F., Zhang, S., & Hong, S. (1999). Sample Size in Factor Analysis. *Psychological Methods*, 4(1), 84-99.
- Madni, A. M., & Sievers, M. (2014). Systems Integration- Key Perspectives, Experiences, and Challenges. *Systems Engineering*, 17(1), 37-51. doi:10.1002/sys.21249
- 10.1002/sys
- Mahidhar, V. (2005). *Designing the Lean Enterprise Performance Measurement System*. (Master of Science in Engineering Systems), Massachusetts Institute of Technology.

- Maier, M. W., & Rechtin, E. (2009). *The Art Of Systems Architecting* (3 ed.). Boca Raton, FL: CRC Press.
- Malhotra, N. K., Hall, J., Shaw, M., & Oppenheim, P. (2004). *Essentials of marketing research : an applied orientation*. Frenchs Forest, NSW: Pearson Education Australia.
- Mueller, C. W. (2004). *Conceptualization, Operationalization, and Measurement*. *The SAGE Encyclopedia of Social Science Research Methods*. Sage Publications, Inc. Thousand Oaks, CA: Sage Publications, Inc.
- Müller, R., Söderland, J., & Jugdev, K. (2012). Critical success factors in projects. *International Journal of Managing Projects in Business*, 5(4), 757-775. doi:10.1108/17538371211269040
- Myers, M. D., & Newman, M. (2007). The qualitative interview in IS research: Examining the craft. *Information and Organization*, 17(1), 2-26. doi:10.1016/j.infoandorg.2006.11.001
- NASA. (2003). *Columbia Accident Investigation Report*. Washington, DC: NASA.
- NASA. (2007). *NASA Systems Engineering Handbook*. Washington, D.C.
- NASA. (2012). *Launch Services Risk Mitigation Policy for NASA-Owned and/or NASA-Sponsored Payloads/Missions*. (NPD 8601.7D). Washington, D.C.: NASA.
- Newman, J. S. (2001). Failure-space - A systems engineering look at 50 space system failures. *Acta Astronautica*, 48(5), 517-527.
- Niazi, M., Wilson, D., & Zowghi, D. (2005). A framework for assisting the design of effective software process improvement implementation strategies. *Journal of Systems and Software*, 78(2), 204-222. doi:10.1016/j.jss.2004.09.001
- Nicholas, J. M., & Steyn, H. (2012). *Project Management for Engineering, Business and Technology* (4th ed.). New York, NY: Routledge.
- Office of Management and Budget. (2005). *Federal Acquisition Regulation*. Washington, D.C.: Office of Management and Budget.
- Oppenheim, B. W., Murman, E. M., & Secor, D. A. (2011). Lean Enablers for Systems Engineering. *Systems Engineering*, 14(1), 29-55. doi:10.1002/sys.20161
- Patankar, M. S., Brown, J. P., Sabin, E. J., & Bigda-Peyton, T. G. (2012). *Safety Culture: Building and Sustaining a Cultural Change in Aviation and Healthcare*: Ashgate Publishing.
- Pawlikowski, E. M. (2010). Mission Assurance—A Key Part of Space. *Senior Leader Perspective*, 6-9.
- Pennell, L. W., & Knight, F. L. (2005). USAF-Aerospace Corp Systems Engineering Handbook.
- Piasczyk, C. (2011). Model Based Systems Engineering with Department of Defense Architectural Framework. *Systems Engineering*, 14(3), 305-326. doi:10.1002/sys.20180
- Rabin, M., & Schrag, J. L. (1999). First Impressions Matter: Model of Confirmatory Bias. *The Quarterly Journal of Economics*, 114(1), 37-82.

- RAmos, A. L., Ferreira, J. V., & Barcelo, J. (2012). Model-Based Systems Engineering- An Emerging Approach for Modern Systems. *IEEE Transactions on Systems, Man, and Cybernetics - Part C*, 42(1), 101-111.
- Randt, F. J. d., Waveren, C. C. v., & Chan, K.-Y. (2014). An empirical study on the critical success factors of small- to medium-sized projects. *The South African Journal of Industrial Engineering*, 25(2), 13-28.
- Reigle, R. F. (2015). Measuring Organic and Mechanistic Cultures. *Engineering Management Journal*, 13(4), 3-8. doi:10.1080/10429247.2001.11415132
- Rhodes, D. H., Valerdi, R., & Roedler, G. J. (2009). Systems engineering leading indicators for assessing program and technical effectiveness. *Systems Engineering*, 12(1), 21-35. doi:10.1002/sys.20105
- Roedler, G. J., & Jones, C. (2005). *Technical Measurement Guide*. Retrieved from
- Sage, A. P., & Lynch, C. L. (1998). Systems Integration and Architecting- An Overview of Principles, Practices, and Perspectives. *Systems Engineering*, 1(3), 176-227.
- Santos, J. R. A. (1999). Cronbach's Alpha: A Tool for Assessing the Reliability of Scales. *Journal of Extension*, 37(2).
- Sauvageau, D. R., & Allen, B. D. (1998, July 13-15, 1998). *Launch Vehicle Historical Reliability*. Paper presented at the 34th AIAA/ASME/SAE/ASEE Joint Propulsion Conference & Exhibit, Cleveland, OH.
- Schapiro, S. B., & Henry, M. H. (2012). Engineering Agile Systems through Architectural Modularity. *2012 IEEE International Systems Conference SysCon 2012*, 1-6.
- Schein, E. H. (1990). Organizational Culture. *American Psychologist*, 109-119.
- Schein, E. H. (2004). *Organizational Culture and Leadership* (3rd ed.). San Francisco, CA: Jossey-Bass.
- Schumacker, R. E., & Lomax, R. G. (2010). *A Beginner's Guide to Structural Equation Modeling* (3rd ed.). New York: Routledge.
- SEBoK authors. (2016). Guide to the Systems Engineering Body of Knowledge (SEBoK). In B. E. Board (Ed.), (Vol. 1.7). Hoboken, NJ: The Trustees of the Stevens Institute of Technology.
- Segura Morales, M. A. (2014). *Effects of Geographic and Demographic Dispersion on the Performance of Systems Engineering Teams*. (3622672 Ph.D.), The George Washington University, Ann Arbor. Retrieved from <https://login.ezproxy.net.ucf.edu/login?url=http://search.proquest.com/docview/1548332419?accountid=10003>
- http://sfx.fcla.edu/ucf?url_ver=Z39.88-2004&rft_val_fmt=info:ofi/fmt:kev:mtx:dissertation&genre=dissertations+%26+theses&sid=ProQ:ProQuest+Dissertations+%26+Theses+A%26I&atitle=&title=Effects+of+Geographic+and+Demographic+Dispersion+on+the+Performance+of+Systems+Engineering

[+Teams&issn=&date=2014-01-01&volume=&issue=&spage=&au=Segura+Morales%2C+Marco+Antonio&isbn=9781303945458&jtitle=&bttitle=&rft_id=info:eric/&rft_id=info:doi/](#) ProQuest Dissertations & Theses A&I; ProQuest Dissertations & Theses Global database.

- SEI. (2010). *Capability Maturity Model Integrated for Development*. Retrieved from Hanscom AFB, MA:
- Shenhar, A. J., Tishler, A., Dvir, D., Lipovetsky, S., & Lechler, T. (2002). Refining the search for project success factors: a multivariate, typological approach. *R & D Management*, 32(2), 111-126.
- Slegers, N. J., Kadish, R. T., Payton, G. E., Thomas, J., Griffin, M. D., & Dumbacher, D. (2012). Learning from Failure in Systems Engineering - A Panel Discussion. *Systems Engineering*, 15(1), 74-82. doi:10.1002/sys.20195
- 10.1002/sys
- Slevin, J. P. D. (1987). Critical Factors in Successful Project Implementation. *IEEE Transactions on Engineering Management*, 34(1), 22-27.
- Smartt, C., & Ferreira, S. (2010). Constructing a General Framework for Systems Engineering Strategy. *Systems Engineering*, 15(2), 140-152. doi:10.1002/sys.20199
- Snee, R. D. (2010). Lean Six Sigma - Getting Better All the Time. *International Journal of Lean Six Sigma*, 1(1), 9-29.
- Son, S. K., & Kim, S.-K. (2012). The Impact of Systems Engineering on Program Performance: A Case Study of the Boeing Company. 203, 537-545. doi:10.1007/978-94-007-5699-1_54
- Stelzmann, E. (2012). Contextualizing Agile Systems Engineering. *IEEE Aerospace and Electronic Systems Magazine*, 27(5), 17-22.
- Stelzmann, E., Kreiner, C., Spork, G., Messnarz, R., & Koenig, F. (2010). *Agility Meets Systems engineering: A Catalogue of Success Factors from Industry Practice*. Paper presented at the Systems, Software and Services Process Improvement 17th European Conference, Grenoble, France.
- Suhr, D. D. (2006). *Exploratory or Confirmatory Factor Analysis?* Paper presented at the Thirty-first Annual SAS Users Group International Conference, Cary, NC.
- Tabachnick, B. G., & Fidell, L. S. (2013). *Using Multivariate Statistics* (6th Ed.). Boston: Pearson.
- Taylor-Powell, E. (2009). What is Sampling Bias. University of Wisconsin: Board of Regents of the University of Wisconsin System.
- Taylor, J. B. (2010). *Safety culture : assessing and changing the behaviour of organizations*. Surrey, England: Ashgate Publishing.

- Thayer-Hart, N., Elver, K., Schaeffer, N. C., & Stevenson, J. (2010). *Survey Fundamentals: A Guide to Designing and Implementing Surveys (Vol. 2)*. Madison, WI: University of Wisconsin.
- Tremaine, R. (2009). A new acquisition brew - systems engineering and lean six sigma make a great mix. *Defense AR Journal*, 16(1), 97-115.
- Tudor, D., & Walter, G. A. (2006). *Using an Agile Approach in a Large, Traditional Organization*. Paper presented at the AGILE Conference, Minneapolis, MN.
- Turner, R. (2007). Toward Agile Systems Engineering Processes. *Crosstalk. The Journal of Defense Software Engineering*, 11-15.
- USAF, NRO, & NASA. (2011). Memorandum of Understanding between USAF, NRO & NASA for New Entrant Launch Vehicle Certification.
- Valerdi, R. (2005). *The Constructive Systems Engineering Cost Model (COSYSMO)*. (3196910 Ph.D.), University of Southern California, Ann Arbor. Retrieved from <https://login.ezproxy.net.ucf.edu/login?url=http://search.proquest.com/docview/305430250?accountid=10003>
- http://sfx.fcla.edu/ucf?url_ver=Z39.88-2004&rft_val_fmt=info:ofi/fmt:kev:mtx:dissertation&genre=dissertations+%26+theses&sid=ProQ:ProQuest+Dissertations+%26+Theses+A%26I&atitle=&title=The+constructiv+e+systems+engineering+cost+model+%28COSYSMO%29&issn=&date=2005-01-01&volume=&issue=&spage=&au=Valerdi%2C+Ricardo&isbn=9780542427831&jtitle=&bttitle=&rft_id=info:eric/&rft_id=info:doi/ ProQuest Dissertations & Theses A&I; ProQuest Dissertations & Theses Global database.
- Valerdi, R., & Davidz, H. L. (2009). Empirical research in systems engineering: challenges and opportunities of a new frontier. *Systems Engineering*, 12(2), 169-181. doi:10.1002/sys.20117
- Vandenberg, R. J., & Scarpello, V. (1990). The matching model: An examination of the processes underlying realistic job previews. *Journal of Applied Psychology*, 75(1), 60-67.
- Vanek, F., Jackson, P., & Grzybowski, R. (2008). Systems engineering metrics and applications in product development- A critical literature review and agenda for further research. *Systems Engineering*, 11(2), 107-124. doi:10.1002/sys.20089
- Welo, T., Tonning, O. R. B., & Rølvåg, T. (2013). Lean Systems Engineering (LSE) - Hands-on Experiences in Applying LSE to a Student Eco-Car Build Project. *Procedia Computer Science*, 16, 492-501. doi:10.1016/j.procs.2013.01.052
- Westerveld, E. (2003). The Project Excellence Model: linking success criteria and critical success factors. *International Journal of Project Management*, 21, 411-418. doi:10.1016/s0263-7863(03)00062-0
- Whitcomb, C., Khan, R., & White, C. (2014). *Development of a System Engineering Competency Career Development Model: an analytical approach using Bloom's Taxonomy*. Retrieved from Monterey, CA: <http://hdl.handle.net/10945/44705>

Yin, R. K. (2009). *Case Study Research: Design and Methods* (Fourth ed. Vol. 5). Thousand Oaks: SAGE Publications.

Zheng, W. (2005). *The impact of organizational culture, structure, and strategy on knowledge management effectiveness and organizational effectiveness.*